



Test Report issued under the responsibility of:



TEST REPORT IEC 60335-2-15 Safety of household and similar electrical appliances Part 2: Particular requirements for appliances for heating liquids	
Report Number	190820009GZU-001
Date of issue	17 Feb., 2020
Total number of pages	216 pages
Name of Testing Laboratory preparing the Report	Intertek Testing Services Shenzhen Ltd. Guangzhou Branch
Applicant's name	Guangzhou Taipeng Electrical Appliances Technology Co., Ltd.
Address	No. 26-27, 9 Floor, Tower A, Cairun International Mansion, No. 2 Dongguanzhuang Road, Tianhe District, Guangzhou, Guangdong, P.R. China
Test specification:	
Standard	IEC 60335-2-15:2012, AMD1:2016, AMD2:2018 for use in conjunction with IEC 60335-1:2010, COR1:2010, COR2:2011, AMD1:2013, COR1:2014, AMD2:2016, COR1:2016
Test procedure	CB Scheme
Non-standard test method	N/A
Test Report Form No.	IEC60335_2_15P
Test Report Form(s) Originator	IMQ S.p.A.
Master TRF	Dated 2019-04-02
Copyright © 2019 IEC System of Conformity Assessment Schemes for Electrotechnical Equipment and Components (IECEE System). All rights reserved. This publication may be reproduced in whole or in part for non-commercial purposes as long as the IECEE is acknowledged as copyright owner and source of the material. IECEE takes no responsibility for and will not assume liability for damages resulting from the reader's interpretation of the reproduced material due to its placement and context. If this Test Report Form is used by non-IECEE members, the IECEE/IEC logo and the reference to the CB Scheme procedure shall be removed. This report is not valid as a CB Test Report unless signed by an approved CB Testing Laboratory and appended to a CB Test Certificate issued by an NCB in accordance with IECEE 02.	
General disclaimer:	
The test results presented in this report relate only to the object tested. This report shall not be reproduced, except in full, without the written approval of the Issuing CB Testing Laboratory. The authenticity of this Test Report and its contents can be verified by contacting the NCB, responsible for this Test Report.	

Test item description :	Electric kettle
Trade Mark :	TAIPENG
Manufacturer	Guangzhou Taipeng Electrical Appliances Technology Co., Ltd. No. 26-27, 9 Floor, Tower A, Cairun International Mansion, No. 2 Dongguanhuang Road, Tianhe District, Guangzhou, Guangdong, P.R. China
Model/Type reference :	TPGK1318-15, TPGK1318-18, TPGK1218-15, TPGK1218-18, TPGK2218-15, TPGK2218-18, TPSK0315-15, TPSK0315-18, TPSK0515-15, TPSK0515-18, TPSK0318-15, TPSK0318-18, TPSK0518-15, TPSK0518-18, TPSK5218SS-15, TPSK5218SS-18, TPSK7318-15, TPSK7318-18, TPSK7425-15, TPSK7425-18, TPSK7625-15, TPSK7625-18, TPSK8518-15, TPSK8518-18, TPSK8815-15, TPSK8815-18, TPCK0118-18, TPCK0225-18, TPCK0318-18, TPCK0418-18, TPCK0508-13
Ratings :	220-240 V, 50/60 Hz, Class I, TPGK1318-15, TPGK1218-15, TPGK2218-15, TPSK0315-15, TPSK0515-15, TPSK0318-15, TPSK0518-15, TPSK5218SS-15, TPSK7318-15, TPSK7425-15, TPSK7625-15, TPSK8518-15, TPSK8815-15: 1500 W, TPGK1318-18, TPGK1218-18, TPGK2218-18, TPSK0315-18, TPSK0515-18, TPSK0318-18, TPSK0518-18, TPSK5218SS-18, TPSK7318-18, TPSK7425-18, TPSK7625-18, TPSK8518-18, TPCK0118-18, TPCK0225-18, TPCK0318-18, TPCK0418-18, TPSK8815-18: 1800W, TPCK0508-13: 1350 W

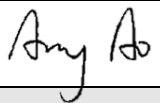
Responsible Testing Laboratory (as applicable), testing procedure and testing location(s):		
<input checked="" type="checkbox"/>	CB Testing Laboratory:	Intertek Testing Services Shenzhen Ltd. Guangzhou Branch
Testing location/ address		Block E, No.7-2 Guang Dong Software Science Park, Caipin Road, Guangzhou Science City, GETDD, Guangzhou, China
Tested by (name, function, signature)..... :		Jet Wu / Project Engineer 
Approved by (name, function, signature) .. :		Amy Ao/ Supervisor 
<input type="checkbox"/>	Testing procedure: CTF Stage 1:	N/A
Testing location/ address		
Tested by (name, function, signature)..... :		
Approved by (name, function, signature) .. :		
<input type="checkbox"/>	Testing procedure: CTF Stage 2:	N/A
Testing location/ address		
Tested by (name, function, signature)..... :		
Witnessed by (name, function, signature) . :		
Approved by (name, function, signature) .. :		
<input type="checkbox"/>	Testing procedure: CTF Stage 3:	N/A
<input type="checkbox"/>	Testing procedure: CTF Stage 4:	N/A
Testing location/ address		
Tested by (name, function, signature)..... :		
Witnessed by (name, function, signature) . :		
Approved by (name, function, signature) .. :		
Supervised by (name, function, signature) :		

List of Attachments (including a total number of pages in each attachment):

Including 95 pages of photo documents (from page 121 to 215).
Including 1 pages of circuit diagram (on page 216).

Summary of testing:

The submitted samples were tested and found to compliance with requirements of the standard IEC 60335-1: 2010 + A1: 2013 + A2: 2016 and IEC 60335-2-15: 2012 + A1: 2016 + A2: 2018.

Tests performed (name of test and test clause):

Full tests were conducted on model TPGK1218-18, TPSK0318-18, TPCK0118-18, TPSK7625-18. Models TPCK0508-13, TPGK1318-15 were subjected to tests of clause 7, 10, 11, 13, 15, 16, 29, 30 and construction check. Other models were subjected to tests of clause 7, 8, 29 and construction check.

Testing location:

Intertek Testing Services Shenzhen Ltd.
Guangzhou Branch
Block E, No.7-2 Guang Dong Software Science Park, Caipin Road, Guangzhou Science City, GETDD, Guangzhou, China

Summary of compliance with National Differences (List of countries addressed):

None.

Copy of marking plate:

The artwork below may be only a draft. The use of certification marks on a product must be authorized by the respective NCBs that own these marks.



Remark: Marking plates for other models are same as above, except for model name and rated power input.

Test item particulars: Classification of installation and use Portable appliance for household and indoor use only Supply Connection Non-detachable cord fitted with a plug	
Possible test case verdicts: - test case does not apply to the test object N/A - test object does meet the requirement P (Pass) - test object does not meet the requirement F (Fail)	
Testing: Date of receipt of test item 20 Aug., 2019 Date (s) of performance of tests 20 Aug., 2019 to 17 Feb., 2020	
General remarks: "(See Enclosure #)" refers to additional information appended to the report. "(See appended table)" refers to a table appended to the report. Throughout this report a <input checked="" type="checkbox"/> comma / <input type="checkbox"/> point is used as the decimal separator. Determination of the test conclusion is based on IEC Guide 115 in consideration of measurement uncertainty. This report is for the exclusive use of Intertek's Client and is provided pursuant to the agreement between Intertek and its Client. Intertek's responsibility and liability are limited to the terms and conditions of the agreement. Intertek assumes no liability to any party, other than to the Client in accordance with the agreement, for any loss, expense or damage occasioned by the use of this report. Only the Client is authorized to permit copying or distribution of this report and then only in its entirety. Any use of the Intertek name or one of its marks for the sale or advertisement of the tested material, product or service must first be approved in writing by Intertek. The observations and test results in this report are relevant only to the sample tested. This report by itself does not imply that the material, product, or service is or has ever been under an Intertek certification program. The test report only allows to be revised only within the report defined retention period unless standard or regulation was withdrawn or invalid.	
Manufacturer's Declaration per Subclause 4.2.5 of IEC60335-1:	
The application for obtaining a CB Test Certificate includes more than one factory location and a declaration from the Manufacturer stating that the sample(s) submitted for evaluation is (are) representative of the products from each factory has been provided.....:	<input type="checkbox"/> Yes <input checked="" type="checkbox"/> Not applicable
When differences exist; they shall be identified in the General product information section.	
Name and address of factory (ies) Lianjiang Shi Xiandai Shenghuo Electric Appliances Co., Ltd. No. 8 Longhua Street Jiuzhoujiang Economic Development Zone, Lianjiang, Guangdong, P.R. China	

General product information:

Cordless kettles are for household and indoor use only.

All models use the same circuit diagram, incorporating one temperature limiter on handle and two thermal cut-outs on kettle bottom.

See below table for model differences:

Model	Ratings	Capacity	Kettle body material	Thermal control
TPGK1318-15	220-240V, 1500W	1,8L	Glass	Fada, ZUANBAO, Tianming or FUFAN
TPGK1318-18	220-240V, 1800W	1,8L	Glass	
TPGK1218-15	220-240V, 1500W	1,8L	Glass	
TPGK1218-18	220-240V, 1800W	1,8L	Glass	
TPGK2218-15	220-240V, 1500W	1,8L	Glass	
TPGK2218-18	220-240V, 1800W	1,8L	Glass	
TPSK0315-15	220-240V, 1500W	1,5L	Metal	
TPSK0315-18	220-240V, 1800W	1,5L	Metal	
TPSK0515-15	220-240V, 1500W	1,5L	Metal	
TPSK0515-18	220-240V, 1800W	1,5L	Metal	
TPSK0318-15	220-240V, 1500W	1,8L	Metal	
TPSK0318-18	220-240V, 1800W	1,8L	Metal	
TPSK0518-15	220-240V, 1500W	1,8L	Metal	
TPSK0518-18	220-240V, 1800W	1,8L	Metal	
TPSK5218SS-15	220-240V, 1500W	1,8L	Metal	
TPSK5218SS-18	220-240V, 1800W	1,8L	Metal	
TPSK7318-15	220-240V, 1500W	1,8L	Metal	
TPSK7318-18	220-240V, 1800W	1,8L	Metal	
TPSK7425-15	220-240V, 1500W	2,5L	Metal wrapped by plastic	
TPSK7425-18	220-240V, 1800W	2,5L	Metal wrapped by plastic	
TPSK7625-15	220-240V, 1500W	2,5L	Metal	
TPSK7625-18	220-240V, 1800W	2,5L	Metal	
TPSK8518-15	220-240V, 1500W	1,8L	Metal	
TPSK8518-18	220-240V, 1800W	1,8L	Metal	
TPSK8815-15	220-240V, 1500W	1,5L	Metal wrapped by plastic	
TPSK8815-18	220-240V, 1800W	1,5L	Metal wrapped by plastic	
TPCK0118-18	220-240V, 1800W	1,8L	Metal wrapped by plastic	
TPCK0225-18	220-240V, 1800W	2,5L	Metal	
TPCK0318-18	220-240V, 1800W	1,8L	Metal wrapped by plastic	
TPCK0418-18	220-240V, 1800W	1,8L	Metal	

TPCK0508-13	220-240V, 1350W	0,8L	Metal	
-------------	-----------------	------	-------	--

IEC 60335-2-15			
Clause	Requirement + Test	Result - Remark	Verdict
5	GENERAL CONDITIONS FOR THE TESTS		--
	Tests performed according to Clause 5, e.g. nature of supply, sequence of testing, etc.		P
5.2	If the test of 15.101 has to be carried out, three additional samples are required (IEC 60335-2-15)		N/A
5.3	Test of 19.101, carried out after the other tests (IEC 60335-2-15)		P
5.10	A class III construction part of the appliance is tested connected to its detachable power supply part taking into account the instructions provided with the appliance		N/A
5.101	Induction rice cookers tested as motor-operated appliances (IEC 60335-2-15)		N/A
6	CLASSIFICATION		--
6.1	Protection against electric shock: Class 0, 0I, I, II, III	Class I	P
	For a class III construction with a detachable power supply part the appliance is classified according to the detachable power supply part		N/A
6.2	Protection against harmful ingress of water		N/A
	Wash boilers and livestock feed boilers at least IPX3 (IEC 60335-2-15)		N/A
7	MARKING AND INSTRUCTIONS		--
7.1	Rated voltage or voltage range (V)	220-240 V	P
	Symbol for nature of supply, or	~	P
	Rated frequency (Hz)	50/60 Hz	P
	Rated power input (W), or	See page 2.	P
	Rated current (A)		N/A
	Manufacturer's or responsible vendor's name, trademark or identification mark	TAIPENG	P
	Model or type reference	See page 2.	P
	Symbol IEC 60417-5172, for class II appliances		N/A
	IP number, other than IPX0.....	IPX0	N/A
	Symbol IEC 60417-5180 (2003-02), for class III appliances, unless		N/A
	the appliance is operated by batteries only, or		N/A
	for appliances powered by rechargeable batteries recharged in the appliance		N/A

IEC 60335-2-15			
Clause	Requirement + Test	Result - Remark	Verdict
	Symbol IEC 60417-5018, for class II and class III appliances incorporating a functional earth		N/A
	Symbol IEC 60417-5036, for the enclosure of electrically-operated water valves in external hose-sets for connection of an appliance to the water mains, if the working voltage exceeds extra-low voltage		N/A
	Appliances intended to be partially immersed in water for cleaning, marked with the maximum level of immersion, and (IEC 60335-2-15)		N/A
	with the substance of the following: "Do not immerse beyond this level" (IEC 60335-2-15)		N/A
	For kettles: level mark or other means which indicate the rated capacity, unless (IEC 60335-2-15)		P
	they cannot be filled beyond their rated capacity (IEC 60335-2-15)		N/A
	Indication visible white kettle in filling position (IEC 60335-2-15)		P
	Reference to the level mark on the outside of the kettle, if the level is not self-evident (IEC 60335-2-15)		P
	Marking on the appliance of the closed position of the lid of pressure cooker, if it is not obvious (IEC 60335-2-15)		N/A
	Identification mark and model or type reference of stand for cordless kettles (IEC 60335-2-15)		P
	Soy milk makers: level mark or other means to indicate when they are filled to rated capacity, unless (IEC 60335-2-15)		N/A
	they cannot be filled beyond their rated capacity (IEC 60335-2-15)		N/A
7.2	Warning for stationary appliances for multiple supply		N/A
	Warning placed in vicinity of terminal cover		N/A
7.3	Range of rated values marked with the lower and upper limits separated by a hyphen		P
	Different rated values marked with the values separated by an oblique stroke		N/A
7.4	Appliances adjustable for different rated voltages or rated frequencies, the voltage or the frequency setting is clearly discernible		N/A

IEC 60335-2-15			
Clause	Requirement + Test	Result - Remark	Verdict
	Requirement met if frequent changes are not required and the rated voltage or rated frequency to which the appliance is to be adjusted is determined from a wiring diagram		N/A
7.5	Appliances with more than one rated voltage or one or more rated voltage ranges, marked with rated input or rated current for each rated voltage or range, unless		N/A
	the power input or current are related to the arithmetic mean value of the rated voltage range		P
	Relation between marking for upper and lower limits of rated power input or rated current and voltage is clear		N/A
7.6	Correct symbols used		P
	Symbol for nature of supply placed next to rated voltage		P
	Symbol for class II appliances placed unlikely to be confused with other marking		N/A
	Units of physical quantities and their symbols according to international standardized system		P
7.7	Connection diagram fixed to appliances to be connected to more than two supply conductors and appliances for multiple supply, unless		N/A
	correct mode of connection is obvious		N/A
7.8	Except for type Z attachment, terminals for connection to the supply mains indicated as follows:		--
	- marking of terminals exclusively for the neutral conductor (letter N)		N/A
	- marking of protective earthing terminals (symbol IEC 60417-5019)		P
	- marking of functional earthing terminals (symbol IEC 60417-5018)		N/A
	- marking not placed on removable parts		P
7.9	Marking or placing of switches which may cause a hazard		P
7.10	Indications of switches on stationary appliances and controls on all appliances by use of figures, letters or other visual means	By figures and indicators	P
	This applies also to switches which are part of a control		P

IEC 60335-2-15			
Clause	Requirement + Test	Result - Remark	Verdict
	If figures are used, the OFF position indicated by the figure 0		P
	The figure 0 indicates only OFF position, unless no confusion with the OFF position		P
7.11	Indication for direction of adjustment of controls		N/A
7.12	Instructions for safe use provided		P
	Details concerning precautions during user maintenance		P
	The instructions state that:		--
	- the appliance is not to be used by persons (including children) with reduced physical, sensory or mental capabilities, or lack of experience and knowledge, unless they have been given supervision or instruction		P
	- children being supervised not to play with the appliance		P
	For a part of class III construction supplied from a detachable power supply unit, the instructions state that the appliance is only to be used with the unit provided		N/A
	Instructions for class III appliances state that it must only be supplied at SELV, unless		N/A
	it is a battery-operated appliance, the battery being charged outside the appliance		N/A
	For appliances for altitudes exceeding 2 000 m, the maximum altitude is stated..... :		N/A
	The instructions for appliances incorporating a functional earth states that the appliance incorporates an earth connection for functional purposes only		N/A
	The instructions for appliances include the substance of the following: (IEC 60335-2-15)		--
	This appliance is intended to be used in household and similar applications such as: (IEC 60335-2-15)		P
	- staff kitchen areas in shops, offices and other working environments;		P
	- farm houses;		P
	- by clients in hotels, motels and other residential type environments;		P
	- bed and breakfast type environments		P

IEC 60335-2-15			
Clause	Requirement + Test	Result - Remark	Verdict
	If the manufacturer wants to limit the use of the appliance to less than the above, this is clearly stated in the instructions (IEC 60335-2-15)		N/A
	Appliance incorporating an appliance inlet and intended to be immersed for cleaning, instructions include the following: (IEC 60335-2-15)		--
	- the connector must be remove before cleaning;		N/A
	- the appliance inlet must be dried before the appliance is used again		N/A
	The instructions for appliances normally cleaned after use and not intended to be immersed in water for cleaning, state that the appliance must not be immersed (IEC 60335-2-15)		P
	This requirement normally applies to coffee-makers, cooking pans, milk heaters, pressure cookers, steam cookers, slow cookers, soy milk makers and yoghurt makers (IEC 60335-2-15)		N/A
	The instructions for use for appliances intended to be used with a connector incorporating a thermostat, state that only the appropriate connector must be used (IEC 60335-2-15)		N/A
	Unless, kettles are constructed so that a hazard cannot arise from boiling water being ejected, the instructions for use include the following: (IEC 60335-2-15)		--
	- if the kettle is overfilled, boiling water may be ejected		P
	The instructions for use for kettles filled through a lid aperture which is situated below the handle, include the substance of the following: (IEC 60335-2-15)		--
	- WARNING: "Do not remove the lid while the water is boiling"		N/A
	- WARNING: "Position the lid so that steam is directed away from the handle"		N/A
	The caution statement is not required if the lid can only be closed so that steam is directed away from the handle (IEC 60335-2-15)		N/A
	The instructions for cordless appliances state that the appliance is only to be used with the stand provided (IEC 60335-2-15)		P
	If the appliance and stand of cordless appliances can be lifted together by gripping the handle of the appliance, the instructions include the substance of the following: (IEC 60335-2-15)		--
	- CAUTION: Insure that the appliance is switched off before removing it from its stand		N/A
	Instructions for feeding-bottle heaters: (IEC 60335-2-15)		--

IEC 60335-2-15			
Clause	Requirement + Test	Result - Remark	Verdict
	- state that the food should not be heated for too long a period;		N/A
	- state how to check that the correct food temperature has not been exceeded		N/A
	The instructions for feeding-bottle heaters that do not switch off automatically shall additionally include an instruction to switch off the feeding-bottle heater after use (IEC 60335-2-15, AMD2)		N/A
	Instructions for pressure cookers, other than dynamic pressure cookers: (IEC 60335-2-15)		--
	- state that the ducts in the pressure regulator allowing the escape of steam should be checked regularly to ensure that they are not blocked		N/A
	Instructions for pressure cookers: (IEC 60335-2-15)		--
	- give details of how to open the container safely;		N/A
	- and state that the container must not be opened until the pressure has decreased sufficiently		N/A
	The instructions for use for egg boilers provided with a pricking device contain the substance of the following: (IEC 60335-2-15)		--
	- CAUTION: "Avoid injuries from the egg pricking device"		N/A
	Instructions for espresso coffee-makers incorporating a pressurized reservoir filled by the user: (IEC 60335-2-15)		--
	- contain information for the safe refilling of the water reservoir and the substance of the following:		N/A
	- WARNING: The filling aperture must not be opened during use		N/A
	The instructions for all appliances include: (IEC 60335-2-15)		--
	- a warning to avoid spillage on the connector;		P
	- details on how to clean the surfaces in contact with food;		P
	- a warning of potential injury from misuse;		P
	- a statement that the heating element surface is subject to residual heat after use		P
	The instructions for soy milk makers also include a statement that care shall be taken when handling the sharp cutting blades, emptying the container and during cleaning (IEC 60335-2-15)		N/A
	The instruction for soy milk makers incorporating a switch necessary for compliance with 22.40 include the substance of the following: (IEC 60335-2-15)		--

IEC 60335-2-15			
Clause	Requirement + Test	Result - Remark	Verdict
	- Switch off the appliance and disconnect from supply before changing accessories or approaching parts that move in use		N/A
	The instructions for coffee-makers other than built-in coffee-makers or those tested in a cabinet, shall state that the coffee-maker shall not be placed in a cabinet when in use (IEC 60335-2-15, AMD1)		N/A
	For coffee-makers having an additional decorative door, and for coffee-makers intended to be used in a cabinet, the instructions shall state that the coffee-maker must be operated with the decorative door open or the cabinet door open (IEC 60335-2-15, AMD1)		N/A
	The instructions for coffee-makers having surfaces of glass, ceramic or similar material that forms part of the enclosure of live parts shall include the substance of the following: (IEC 60335-2-15, AMD1)		--
	WARNING: Do not use the appliance if the surface is cracked		N/A
	The instructions for coffee-makers shall state that cleaning and user maintenance shall not be made by children without supervision (IEC 60335-2-15, AMD1)		N/A
7.12.1	Sufficient details for installation supplied		P
	For an appliance intended to be permanently connected to the water mains and not connected by a hose-set, this is stated		N/A
	If different rated voltages or different rated frequencies are marked, the instructions state what action to be taken to adjust the appliance		N/A
7.12.2	Stationary appliances not fitted with means for disconnection from the supply mains having a contact separation in all poles that provide full disconnection under overvoltage category III, the instructions state that means for disconnection must be incorporated in the fixed wiring in accordance with the wiring rules		N/A
7.12.3	Insulation of the fixed wiring in contact with parts exceeding 50 K during Clause 11; instructions state that the fixed wiring must be protected		N/A
7.12.4	Instructions for built-in appliances:		--
	- dimensions of space;		N/A
	- dimensions and position of supporting and fixing;		N/A

IEC 60335-2-15			
Clause	Requirement + Test	Result - Remark	Verdict
	- minimum distances between parts and surrounding structure;		N/A
	- minimum dimensions of ventilating openings and arrangement;		N/A
	- connection to supply mains and interconnection of separate components;		N/A
	- allow disconnection of the appliance after installation, by accessible plug or a switch in the fixed wiring, unless		N/A
	a switch complying with 24.3		N/A
	For coffee-makers suitable for operation when placed in a cabinet, the minimum dimensions of the cabinet shall be given (IEC 60335-2-15, AMD1)		N/A
7.12.5	Replacement cord instructions, type X attachment with a specially prepared cord		N/A
	Replacement cord instructions, type Y attachment		P
	Replacement cord instructions, type Z attachment		N/A
7.12.6	Caution in the instructions for appliances incorporating a non-self-resetting thermal cut-out that is reset by disconnection of the supply mains, if this cut-out is required to comply with the standard		N/A
7.12.7	Instructions for fixed appliances stating how the appliance is to be fixed		N/A
7.12.8	Instructions for appliances connected to the water mains:		--
	- max. inlet water pressure (Pa) :		N/A
	- min. inlet water pressure, if necessary (Pa) :		N/A
	Instructions concerning new and old hose-sets for appliances connected to the water mains by detachable hose-sets		N/A
7.12.9	Instructions specified in 7.12 and from 7.12.1 to 7.12.8 appear together before any other instructions supplied with the appliance		P
	These instructions may be supplied with the appliance separately from any functional use booklet		P
	They may follow the description of the appliance that identifies parts, or follow the drawings/sketches common to the languages of the instructions		P
	In addition, instructions are also available in an alternative format such as on a website or in a format such as a DVD :		P

IEC 60335-2-15			
Clause	Requirement + Test	Result - Remark	Verdict
7.13	Instructions and other texts in an official language	English	P
7.14	Marking clearly legible and durable, rubbing test as specified		P
	Signal words WARNING, CAUTION, DANGER in uppercase having a height as specified :		N/A
	Uppercase letter of the text explaining the signal word not smaller than 1,6 mm		N/A
	Moulded in, engraved, or stamped markings either raised above or have a depth below the surface of at least 0,25 mm, unless		N/A
	contrasting colours are used		N/A
	Markings checked by inspection, measurement and rubbing test as specified		P
7.15	Markings on a main part		P
	Marking clearly discernible from the outside, if necessary after removal of a cover		P
	For portable appliances, cover can be removed or opened without a tool		N/A
	For stationary appliances, name, trademark or identification mark and model or type reference visible after installation		N/A
	For fixed appliances, name, trademark or identification mark and model or type reference visible after installation according to the instructions		N/A
	Indications for switches and controls placed on or near the components. Marking not on parts which can be positioned or repositioned in such a way that the marking is misleading		P
	The symbol IEC 60417-5018 placed next to the symbol IEC 60417-5172 or IEC 60417-5180		N/A
7.16	Marking of a possible replaceable thermal link or fuse link clearly visible with regard to replacing the link		N/A
8	PROTECTION AGAINST ACCESS TO LIVE PARTS		--
8.1	Adequate protection against accidental contact with live parts		P
8.1.1	Requirement applies for all positions, detachable parts removed		P
	Lamps behind a detachable cover not removed, if conditions met		N/A

IEC 60335-2-15			
Clause	Requirement + Test	Result - Remark	Verdict
	Insertion or removal of lamps, protection against contact with live parts of the lamp cap		N/A
	Use of test probe B of IEC 61032, with a force not exceeding 1 N: no contact with live parts		P
	Use of test probe B of IEC 61032 through openings, with a force of 20 N: no contact with live parts		P
8.1.2	Use of test probe 13 of IEC 61032, with a force not exceeding 1 N, through openings in class 0 appliances and class II appliances/constructions: no contact with live parts		P
	Test probe 13 also applied through openings in earthed metal enclosures having a non-conductive coating: no contact with live parts		N/A
	See Note 101 (IEC 60335-2-15)		N/A
8.1.3	For appliances other than class II, use of test probe 41 of IEC 61032, with a force not exceeding 1 N: no contact with live parts of visible glowing heating elements		N/A
	For a single switching action obtained by a switching device, requirements as specified		N/A
	For appliances with a supply cord and without a switching device, the single switching action may be obtained by the withdrawal of the plug from a socket-outlet		N/A
8.1.4	Accessible part not considered live if:		--
	- safety extra-low a.c. voltage: peak value not exceeding 42,4 V;		N/A
	- safety extra-low d.c. voltage: not exceeding 42,4 V;		N/A
	- or separated from live parts by protective impedance		N/A
	If protective impedance: d.c. current not exceeding 2 mA, and		N/A
	a.c. peak value not exceeding 0,7 mA		N/A
	- for peak values over 42,4 V up to and including 450 V, capacitance not exceeding 0,1 μ F;		N/A
	- for peak values over 450 V up to and including 15 kV, discharge not exceeding 45 μ C;		N/A
	- for peak values over 15 kV, the energy in the discharge not exceeding 350 mJ		N/A

IEC 60335-2-15			
Clause	Requirement + Test	Result - Remark	Verdict
8.1.5	Live parts protected at least by basic insulation before installation or assembly:		--
	- built-in appliances;		N/A
	- fixed appliances;		N/A
	- appliances delivered in separate units		N/A
8.2	Class II appliances and constructions constructed so that there is adequate protection against accidental contact with basic insulation and metal parts separated from live parts by basic insulation only		P
	Only possible to touch parts separated from live parts by double or reinforced insulation		P
9	STARTING OF MOTOR-OPERATED APPLIANCES		--
	Requirements and tests are specified in part 2 when necessary		N/A
10	POWER INPUT AND CURRENT		--
10.1	Power input at normal operating temperature, rated voltage and normal operation not deviating from rated power input by more than shown in Table 1.:	(see appended table)	P
	If the power input varies throughout the operating cycle and the maximum value of the power input exceeds, by a factor greater than two, the arithmetic mean value of the power input occurring during a representative period, the power input is the maximum value that is exceeded for more than 10 % of the representative period		N/A
	Otherwise the power input is the arithmetic mean value		N/A
	Test carried out at upper and lower limits of the ranges for appliances with one or more rated voltage ranges, unless		N/A
	the rated power input is related to the arithmetic mean value		P
	The power input of automatic coffee-makers is measured during one operating cycle that is selectable by the user, such as cleaning, descaling, or selecting a beverage. The measurement starts with the appliance at room ambient temperature (IEC 60335-2-15, AMD1)		N/A
	The operating cycle starts with the activation by the user and ends when the appliance stops the cycle automatically and the next operating cycle can be started by the user (IEC 60335-2-15, AMD1)		N/A

IEC 60335-2-15			
Clause	Requirement + Test	Result - Remark	Verdict
10.2	Current at normal operating temperature, rated voltage and normal operation not deviating from rated current by more than shown in Table 2..... :		N/A
	If the current varies throughout the operating cycle and the maximum value of the current exceeds, by a factor greater than two, the arithmetic mean value of the current occurring during a representative period, the current is the maximum value that is exceeded for more than 10 % of the representative period		N/A
	Otherwise the current is the arithmetic mean value		N/A
	Test carried out at upper and lower limits of the ranges for appliances with one or more rated voltage ranges, unless		N/A
	the rated current is related to the arithmetic mean value of the range		N/A
	The input current of automatic coffee-makers is measured during one operating cycle that is selectable by the user, such as cleaning, descaling, or selecting a beverage. The measurement starts with the appliance at room ambient temperature (IEC 60335-2-15, AMD1)		N/A
	The operating cycle starts with the activation by the user and ends when the appliance stops the cycle automatically and the next operating cycle can be started by the user (IEC 60335-2-15, AMD1)		N/A
11	HEATING		--
11.1	No excessive temperatures in normal use		P
11.2	The appliance is held, placed or fixed in position as described..... :	Away from the walls of the test corner	P
	Portable appliances tested away from the walls of the test corner (IEC 60335-2-15)		P
	Coffee-makers with a decorative door or intended to be used in a cabinet shall be tested with the door open (IEC 60335-2-15, AMD1)		N/A
11.3	Temperature rises, other than of windings, determined by thermocouples		P
	Temperature rises of windings determined by resistance method, unless		N/A
	the windings are non-uniform or it is difficult to make the necessary connections		N/A
	See Note 101 (IEC 60335-2-15)		N/A

IEC 60335-2-15			
Clause	Requirement + Test	Result - Remark	Verdict
11.4	Heating appliances operated under normal operation at 1,15 times rated power input (W) :	$1,15 \times (240/230)^2 \times 1800 \text{ W} = 2254 \text{ W}$ $1,15 \times (240/230)^2 \times 1500 \text{ W} = 1878 \text{ W}$ $1,15 \times (240/230)^2 \times 1350 \text{ W} = 1690 \text{ W}$	P
	If the temperature rise limits are exceeded in appliances incorporating motors, transformers or electronic circuits and if the power input is lower than the rated power input, test repeated with the appliance supplied at 1,06 times rated voltage (IEC 60335-2-15)		N/A
	Appliances with electronic power controls are operated as combined appliances (IEC 60335-2-15, AMD1)		N/A
11.5	Motor-operated appliances operated under normal operation at most unfavourable voltage between 0,94 and 1,06 times rated voltage (V)		N/A
11.6	Combined appliances operated under normal operation at most unfavourable voltage between 0,94 and 1,06 times rated voltage (V)		N/A
	Combined appliances tested as heating appliances (IEC 60335-2-15)		N/A
11.7	Appliances operated for the duration specified in 11.7.101 to 11.7.106 (IEC 60335-2-15)		P
11.7.101	For kettles with temperature limiter: test terminated after second operation of temperature limiter (IEC 60335-2-15)		P
	For kettles with thermostat: test terminated 15 min after the water has attained 95 °C		N/A
	For other kettles: test terminated 5 min after the water has attained 95 °C		N/A
11.7.102	For cooking pans, egg boilers, feeding-bottle heaters, glue pots, livestock feed boilers, milk heaters, sterilizers, wash boilers and for appliances that boil water other than kettles, the test is terminated: (IEC 60335-2-15)		--
	- appliances without a thermal control: 15 min after the water in the container has attained a temperature of 95 °C or the maximum temperature it can attain if this is lower		N/A
	- portable appliances provided with a thermal control: 15 min after the thermal control has operated for the first time		N/A

IEC 60335-2-15			
Clause	Requirement + Test	Result - Remark	Verdict
	- fixed appliances provided with a thermal control: 30 min after the thermal control has operated for the first time		N/A
	- appliances with acoustic signal: 1 min after signal		N/A
	- egg boilers having provision for keeping eggs warm, and appliances having a heated surface intended to keep liquid warm: when steady conditions are established		N/A
11.7.103	Slow cookers, rice cookers, steam cookers and yoghurt makers operated until steady conditions are established (IEC 60335-2-15)		N/A
	Slow cookers pre-warmed in the dry state if this instruction is given		N/A
11.7.104	For espresso coffee-makers, the brewing period is followed by a rest period of 1 min or the period stated in the instructions, if this is longer. The water container is refilled during the rest periods (IEC 60335-2-15, AMD1)		N/A
	For automatic espresso coffee makers and espresso coffee makers, the brewing period is the time necessary to produce the maximum quantity of coffee allowed by the timer or by the capacity of the coffee pot		N/A
	For manual espresso coffee makers, maximum quantity of coffee to be produced specified in the instructions, or		N/A
	the brewing period is the time necessary to produce 100 ml of coffee for each cycle		N/A
	For espresso coffee-makers having an outlet for supplying steam or hot water, the brewing period is immediately followed by a period during which the steam or water is supplied for the time stated in the instructions, or		N/A
	- for espresso coffee makers having an outlet for supplying steam, 1 min;		N/A
	- for espresso coffee makers having an outlet for supplying water, the time necessary to produce 100 ml of water		N/A
	- for espresso coffee-makers having an outlet for supplying steam and an outlet for supplying hot water, 1 min period supplying steam is followed by time necessary to produce 100 ml of water (IEC 60335-2-15, AMD1)		N/A

IEC 60335-2-15			
Clause	Requirement + Test	Result - Remark	Verdict
	Espresso coffee-makers operated until steady conditions are established		N/A
	Other coffee-makers operated for the time necessary to make the maximum quantity of coffee stated in the instructions		N/A
	The container refilled as quickly as possible and the coffee-maker operated again until steady conditions are established		N/A
11.7.105	Pressure cookers operated 15 min after attaining the maximum cooking pressure (IEC 60335-2-15)		N/A
11.7.106	Soy milk makers operated for a complete operating cycle (IEC 60335-2-15)		N/A
11.8	Temperature rises monitored continuously and not exceeding the values in Table 3	(see appended table)	P
	If the temperature rise of a motor winding exceeds the value of Table 3, or		N/A
	if there is doubt with regard to classification of insulation,		N/A
	tests of Annex C are carried out		N/A
	Sealing compound does not flow out		P
	Protective devices do not operate, except		P
	components in protective electronic circuits tested for the number of cycles specified in 24.1.4		N/A
	When an appliance connector incorporates a thermostat, the temperature rise limit for the pins of the inlet does not apply (IEC 60335-2-15)		N/A
	The temperature rise limits of motors, transformers, components of electronic circuit and parts directly influenced by them may be exceeded when the appliance is operated at 1,15 times rated power input (IEC 60335-2-15)		N/A
13	LEAKAGE CURRENT AND ELECTRIC STRENGTH AT OPERATING TEMPERATURE		--
13.1	Leakage current not excessive and electric strength adequate		P
	Heating appliances operated at 1,15 times the rated power input (W)	$1,15 \times (240/230)^2 \times 1800 \text{ W} = 2254 \text{ W}$ $1,15 \times (240/230)^2 \times 1500 \text{ W} = 1878 \text{ W}$ $1,15 \times (240/230)^2 \times 1350 \text{ W} = 1690 \text{ W}$	P

IEC 60335-2-15			
Clause	Requirement + Test	Result - Remark	Verdict
	Motor-operated appliances and combined appliances supplied at 1,06 times the rated voltage (V)		N/A
	Protective impedance and radio interference filters disconnected before carrying out the tests		N/A
13.2	The leakage current is measured by means of the circuit described in Figure 4 of IEC 60990:1999		P
	For class 0I appliances and class I appliances, except parts of class II construction, C may be replaced by a low impedance ammeter		P
	Leakage current measurements.....	(see appended table)	P
13.3	The appliance is disconnected from the supply		P
	Electric strength tests according to Table 4	(see appended table)	P
	No breakdown during the tests		P
14	TRANSIENT OVERVOLTAGES		--
	Appliances withstand the transient over-voltages to which they may be subjected		N/A
	Clearances having a value less than specified in Table 16 subjected to an impulse voltage test, the test voltage specified in Table 6		N/A
	No flashover during the test, unless		N/A
	of functional insulation if the appliance complies with Clause 19 with the clearance short-circuited		N/A
15	MOISTURE RESISTANCE		--
15.1	Enclosure provides the degree of moisture protection according to classification of the appliance	IPX0	N/A
	Compliance checked as specified in 15.1.1, taking into account 15.1.2, followed by the electric strength test of 16.3		N/A
	No trace of water on insulation which can result in a reduction of clearances or creepage distances below values specified in Clause 29		N/A
15.1.1	Appliances, other than IPX0, subjected to tests as specified in IEC 60529		N/A
	Water valves containing live parts in external hoses for connection of an appliance to the water mains tested as specified for IPX7 appliances		N/A
15.1.2	Hand-held appliance turned continuously through the most unfavourable positions during the test		N/A

IEC 60335-2-15			
Clause	Requirement + Test	Result - Remark	Verdict
	Built-in appliances installed according to the instructions		N/A
	Appliances placed or used on the floor or table placed on a horizontal unperforated support		N/A
	Appliances normally fixed to a wall and appliances with pins for insertion into socket-outlets are mounted on a wooden board		N/A
	For IPX3 appliances, the base of wall mounted appliances is placed at the same level as the pivot axis of the oscillating tube		N/A
	For IPX4 appliances, the horizontal centre line of the appliance is aligned with the pivot axis of the oscillating tube, and		N/A
	for appliances normally used on the floor or table, the movement is limited to two times 90° for a period of 5 min, the support being placed at the level of the pivot axis of the oscillating tube		N/A
	Wall-mounted appliances, take into account the distance to the floor stated in the instructions		N/A
	Appliances normally fixed to a ceiling are mounted underneath a horizontal unperforated support, the pivot axis of the oscillating tube located at the level of the underside of the support, and		N/A
	for IPX4 appliances, the movement of the tube is limited to two times 90° from the vertical for a period of 5 min		N/A
	Appliances with type X attachment fitted with a flexible cord as described		N/A
	Detachable parts subjected to the relevant treatment with the main part		N/A
	However, if a part has to be removed for user maintenance and a tool is needed, this part is not removed		N/A
15.2	Spillage of liquid does not affect the electrical insulation		P
	Spillage solution comprising water containing approximately 1 % NaCl and 0,6 % rinsing agent		P
	Appliances with type X attachment fitted with a flexible cord as described		N/A
	Appliances incorporating an appliance inlet tested with or without an connector, whichever is most unfavourable		N/A

IEC 60335-2-15			
Clause	Requirement + Test	Result - Remark	Verdict
	Detachable parts are removed		P
	Overfilling test with additional amount of the solution, over a period of 1 min (I) :		P
	The appliance withstands the electric strength test of 16.3		P
	No trace of water on insulation that can result in a reduction of clearances or creepage distances below values specified in Clause 29		P
	The test is only carried out with the appliance connector in position (IEC 60335-2-15)		P
	In case of doubt, spillage tests carried out with the appliance deviating from the normal position by an angle not exceeding 5° (IEC 60335-2-15)		P
	Kettles that can be filled through the spout: additional overfilling test in conditions as specified (IEC 60335-2-15)		P
	For cordless appliances, the test with the appliance on the horizontal plane carried out with the appliance both on and off its stand (IEC 60335-2-15)		P
	For cordless kettles, the additional test carried out only with the cordless kettle off its stand, the kettle being replaced on its stand in order to carry out the electric strength test of 16.3 (IEC 60335-2-15)		P
	Coffee makers provided with a removable coffee pot: particular overfilling test in conditions as specified (IEC 60335-2-15)		N/A
	Steam sterilizers: particular overfilling test in conditions as specified (IEC 60335-2-15)		N/A
	For rice cookers, the test carried out with the rice container in place (IEC 60335-2-15)		N/A
	Coffee-makers dispensing liquid into a serving container, such as a cup or jug, are tested by steadily pouring 0,5 l of the solution over the surface where the container is filled or the container is transported and removed by the user. If a drop container is placed beneath this surface, the drop container is completely filled before the test is carried out (IEC 60335-2-15, AMD1)		N/A
	Coffee-makers having external surfaces on which it is possible to place a vessel, such as a cup or jug, are tested by pouring 0,2 l of the solution over the complete depositing area in approximately 5 s (IEC 60335-2-15, AMD1)		N/A

IEC 60335-2-15			
Clause	Requirement + Test	Result - Remark	Verdict
	For coffee makers, after each overfilling test or application of liquid, all residues are then removed and the appliance is dried (IEC 60335-2-15, AMD1)		N/A
15.3	Appliances proof against humid conditions	25 °C, 93% R.H.	P
	Checked by test Cab: Damp heat steady state in IEC 60068-2-78		P
	Detachable parts removed and subjected, if necessary, to the humidity test with the main part		P
	Humidity test for 48 h in a humidity cabinet		P
	Reassembly of those parts that may have been removed		P
	The appliance withstands the tests of Clause 16		P
15.101	Appliances to be partially or completely immersed in water for cleaning sufficiently protected against effects of immersion (IEC 60335-2-15)		N/A
	Compliance is checked by the tests as specified, which are carried out on three additional appliances		N/A
	No trace of water on insulation which can result in reduction of creepage distances and clearance below values specified in 29		N/A
15.102	Connecting device of stands for cordless kettles not affected by water: particular electric strength test in conditions as specified (IEC 60335-2-15)		P
	Compliance is checked by the test in conditions as specified		P
	Stand withstanding the test of 16.3 with voltage reduced to 2 500 V for reinforced insulation		P
15.103	Interior of rice cookers not affected by water (IEC 60335-2-15)		N/A
	Compliance is checked by the test as specified		N/A
	Rice cookers withstanding the electric strength test of 16.3		N/A
16	LEAKAGE CURRENT AND ELECTRIC STRENGTH		--
16.1	Leakage current not excessive and electric strength adequate		P
	Protective impedance disconnected from live parts before carrying out the tests		N/A
	Tests carried out at room temperature and not connected to the supply		P

IEC 60335-2-15			
Clause	Requirement + Test	Result - Remark	Verdict
16.2	Single-phase appliances: test voltage 1,06 times rated voltage (V)	1,06 x 240 V = 254,4 V	P
	Three-phase appliances: test voltage 1,06 times rated voltage divided by $\sqrt{3}$ (V).....		N/A
	Leakage current measurements.....	(see appended table)	P
	Limit values doubled if:		--
	- all controls have an OFF position in all poles, or		N/A
	- the appliance has no control other than a thermal cut-out, or		N/A
	- all thermostats, temperature limiters and energy regulators do not have an OFF position, or		N/A
	- the appliance has radio interference filters		N/A
	With the radio interference filters disconnected, the leakage current do not exceed limits specified		N/A
16.3	Electric strength tests according to Table 7	(see appended table)	P
	Test voltage applied between the supply cord and inlet bushing and cord guard and cord anchorage as specified.....	(see appended table)	P
	No breakdown during the tests		P
17	OVERLOAD PROTECTION OF TRANSFORMERS AND ASSOCIATED CIRCUITS		--
	No excessive temperatures in transformer or associated circuits in event of short-circuits likely to occur in normal use		N/A
	Appliance supplied with 1,06 or 0,94 times rated voltage under the most unfavourable short-circuit or overload likely to occur in normal use (V)		N/A
	Basic insulation is not short-circuited		N/A
	Temperature rise of insulation of the conductors of safety extra-low voltage circuits not exceeding the relevant value specified in Table 3 by more than 15 K		N/A
	Temperature of the winding not exceeding the value specified in Table 8		N/A
	However, limits do not apply to fail-safe transformers complying with Subclause 15.5 of IEC 61558-1		N/A
18	ENDURANCE		--
	Requirements and tests are specified in part 2 when necessary		N/A

IEC 60335-2-15			
Clause	Requirement + Test	Result - Remark	Verdict
19	ABNORMAL OPERATION		--
19.1	The risk of fire, mechanical damage or electric shock under abnormal or careless operation obviated		P
	Electronic circuits so designed and applied that a fault will not render the appliance unsafe		N/A
	Appliances incorporating heating elements subjected to the tests of 19.2 and 19.3, and		P
	if the appliance also has a control that limit the temperature during Clause 11 it is subjected to the test of 19.4, and		P
	if applicable, to the test of 19.5		P
	Appliances incorporating PTC heating elements are also subjected to the test of 19.6		N/A
	Appliances incorporating motors subjected to the tests of 19.7 to 19.10, as applicable		N/A
	Appliances incorporating electronic circuits subjected to the tests of 19.11 and 19.12, as applicable		N/A
	Appliances incorporating contactors or relays subjected to the test of 19.14, being carried out before the tests of 19.11		N/A
	Appliances incorporating voltage selector switches subjected to the test of 19.15		N/A
	Unless otherwise specified, the tests are continued until a non-self-resetting thermal cut-out operates, or		P
	until steady conditions are established		P
	If a heating element or intentionally weak part becomes open-circuited, the relevant test is repeated on a second sample		N/A
	Kettles are not subjected to the test of 19.2 (IEC 60335-2-15)		P
	Kettles also subjected to the test of 19.101, unless the appliance incorporates a non-self-resetting thermal cut-out, in order to comply with 19.4 (IEC 60335-2-15)		P
	Kettles for which compliance with 19.101 relies on the operation of a non-self-resetting thermal cut-out are subjected to the test of 19.102 (IEC 60335-2-15)		P

IEC 60335-2-15			
Clause	Requirement + Test	Result - Remark	Verdict
	For appliances with an external surface providing a keep warm function, the test of 19.106 applies (IEC 60335-2-15, AMD1)		N/A
	For coffee-makers having a decorative door, the test of 19.107 applies (IEC 60335-2-15, AMD1)		N/A
	For automatic coffee-makers of the coffee bean type, the tests of 19.108 applies (IEC 60335-2-15, AMD1)		N/A
19.2	Test of appliances with heating elements with restricted heat dissipation; test voltage (V), power input of 0,85 times rated power input (W) :		N/A
	Appliances are placed as near as possible to the walls of the test corner (IEC 60335-2-15)		N/A
	They are tested empty with lids open or closed whichever is the more unfavourable (IEC 60335-2-15)		N/A
	Induction rice cookers operating under the conditions of Clause 11 with the rice container empty (IEC 60335-2-15)		N/A
19.3	Test of 19.2 repeated; test voltage (V), power input of 1,24 times rated power input (W) :		N/A
	Kettles are operated empty at 1,15 times rated power input (IEC 60335-2-15)	1,15 x (240/230) ² x 1800 W= 2254 W	P
	The test is carried out with the kettle filled with sufficient water to cover the heating element or if the heating element is not positioned inside the container, to a depth of 10 mm (IEC 60335-2-15)		P
19.4	Test conditions as in Clause 11, any control limiting the temperature during tests of Clause 11 short-circuited		P
	Pressure cookers: (IEC 60335-2-15)		--
	- all pressure regulating devices rendered inoperative; and		N/A
	- in other than dynamic pressure cookers, all protective devices that vent steam and intentionally weak parts that vent steam rendered inoperative; and		N/A
	- in dynamic pressure cookers, all protective devices, other than intentionally weak parts, that vent steam rendered inoperative		N/A

IEC 60335-2-15			
Clause	Requirement + Test	Result - Remark	Verdict
19.5	Test of 19.4 repeated on class 0I and I appliances with tubular sheathed or embedded heating elements. No short-circuiting, but one end of the element connected to the sheath		P
	The test repeated with reversed polarity and the other end of the heating element connected to the sheath		P
	The test is not carried out on appliances intended to be permanently connected to fixed wiring and on appliances where an all-pole disconnection occurs during the test of 19.4		N/A
19.6	Appliances with PTC heating elements tested at rated voltage, establishing steady conditions		N/A
	The working voltage of the PTC heating element is increased by 5 % and the appliance is operated until steady conditions are re-established. The voltage is then increased in similar steps until 1,5 times working voltage or until the PTC heating element ruptures (V)..... :		N/A
19.7	Stalling test by locking the rotor if the locked rotor torque is smaller than the full load torque, or		N/A
	locking moving parts of other appliances		N/A
	Locked rotor, capacitors open-circuited one at a time		N/A
	Test repeated with capacitors short-circuited one at a time, unless		N/A
	the capacitor is of class S2 or S3 of IEC 60252-1		N/A
	Appliances with timer or programmer supplied with rated voltage for each of the tests, for a period equal to the maximum period allowed..... :		N/A
	An electronic timer or programmer that operates to ensure compliance with the test before the maximum period under the conditions of Clause 11 is reached, is a protective electronic circuit		N/A
	Other appliances supplied with rated voltage for a period as specified :		N/A
	Espresso coffee-makers incorporating a pump operated for a period of 5 min (IEC 60335-2-15)		N/A
	Soy milk makers operated for one cycle of operation (IEC 60335-2-15)		N/A
	Winding temperatures not exceeding values specified in Table 8 :		N/A

IEC 60335-2-15			
Clause	Requirement + Test	Result - Remark	Verdict
19.8	Multi-phase motors operated at rated voltage with one phase disconnected		N/A
19.9	Running overload test on appliances incorporating motors intended to be remotely or automatically controlled or liable to be operated continuously		N/A
	Motor-operated and combined appliances for which 30.2.3 is applicable and that use overload protective devices relying on electronic circuits to protect the motor windings, are also subjected to the test		N/A
	Winding temperatures not exceeding values as specified		N/A
19.10	Series motor operated at 1,3 times rated voltage for 1 min (V)		N/A
	During the test, parts not being ejected from the appliance		N/A
19.11	Electronic circuits, compliance checked by evaluation of the fault conditions specified in 19.11.2 for all circuits or parts of circuits, unless		N/A
	they comply with the conditions specified in 19.11.1		N/A
	Appliances incorporating an electronic circuit that relies upon a programmable component to function correctly, subjected to the test of 19.11.4.8, unless		N/A
	restarting does not result in a hazard		N/A
	Appliances having a device with an OFF position obtained by electronic disconnection, or a device placing the appliance in a stand-by mode, subjected to the tests of 19.11.4		N/A
	If the safety of the appliance under any of the fault conditions depends on the operation of a miniature fuse-link complying with IEC 60127, the test of 19.12 is carried out		N/A
	During and after each test the following is checked:		--
	- the temperature of the windings do not exceed the values specified in Table 8		N/A
	- the appliance complies with the conditions specified in 19.13		N/A
	- any current flowing through protective impedance not exceeding the limits specified in 8.1.4		N/A
	If a conductor of a printed board becomes open-circuited, the appliance is considered to have withstood the particular test, provided both of the following conditions are met:		--

IEC 60335-2-15			
Clause	Requirement + Test	Result - Remark	Verdict
	- the base material of the printed circuit board withstands the test of Annex E		N/A
	- any loosened conductor does not reduce clearance or creepage distances between live parts and accessible metal parts below the values specified in Clause 29		N/A
19.11.1	Fault conditions a) to g) in 19.11.2 are not applied to circuits or parts of circuits meeting both of the following conditions:		--
	- the electronic circuit is a low-power circuit, that is, the maximum power at low-power points does not exceed 15 W according to the tests specified		N/A
	- the protection against electric shock, fire hazard, mechanical hazard or dangerous malfunction of other parts of the appliance does not rely on the correct functioning of the electronic circuit		N/A
19.11.2	Fault conditions applied one at a time, the appliance operating under conditions specified in Clause 11, but supplied at rated voltage, duration of the tests as specified:		--
	a) short circuit of functional insulation if clearances or creepage distances are less than the values specified in Clause 29		N/A
	b) open circuit at the terminals of any component		N/A
	c) short circuit of capacitors, unless		N/A
	they comply with IEC 60384-14		N/A
	d) short circuit of any two terminals of an electronic component, other than integrated circuits		N/A
	This fault condition is not applied between the two circuits of an optocoupler		N/A
	e) failure of triacs in the diode mode		N/A
	f) failure of microprocessors and integrated circuits		N/A
	g) failure of an electronic power switching device		N/A
	Each low power circuit is short-circuited by connecting the low-power point to the pole of the supply source from which the measurements were made		N/A
19.11.3	If the appliance incorporates a protective electronic circuit that operates to ensure compliance with Clause 19, the appliance is tested as specified		N/A
19.11.4	Appliances having a device with an OFF position obtained by electronic disconnection, or		N/A
	a device that can be placed in the stand-by mode,		N/A

IEC 60335-2-15			
Clause	Requirement + Test	Result - Remark	Verdict
	subjected to the tests of 19.11.4.1 to 19.11.4.7, the device being set in the OFF position or in the stand-by mode		N/A
	Appliances incorporating a protective electronic circuit subjected to the tests of 19.11.4.1 to 19.11.4.7, the tests being carried out after the protective electronic circuit has operated, except that		N/A
	appliances operated for 30 s or 5 min during the test of 19.7 are not subjected to the tests for electromagnetic phenomena		N/A
	Surge protective devices disconnected, unless		N/A
	they incorporate spark gaps		N/A
19.11.4.1	The appliance is subjected to electrostatic discharges in accordance with IEC 61000-4-2, test level 4		N/A
19.11.4.2	The appliance is subjected to radiated fields in accordance with IEC 61000-4-3, at frequency ranges specified		N/A
19.11.4.3	The appliance is subjected to fast transient bursts in accordance with IEC 61000-4-4, test level 3 or 4 as specified		N/A
19.11.4.4	The power supply terminals of the appliance subjected to voltage surges in accordance with IEC 61000-4-5, test level 3 or 4 as specified		N/A
	An open circuit test voltage of 2 kV is applicable for the line-to-line coupling mode		N/A
	An open circuit test voltage of 4 kV is applicable for the line-to-earth coupling		N/A
	Earthed heating elements in class I appliances disconnected		N/A
19.11.4.5	The appliance is subjected to injected currents in accordance with IEC 61000-4-6, test level 3		N/A
19.11.4.6	Appliances having a rated current not exceeding 16 A are subjected to the class 3 voltage dips and interruptions in accordance with IEC 61000-4-11		N/A
	Appliances having a rated current exceeding 16 A are subjected to the class 3 voltage dips and interruptions in accordance with IEC 61000-4-34		N/A
19.11.4.7	The appliance is subjected to mains signals in accordance with IEC 61000-4-13, test level class 2		N/A

IEC 60335-2-15			
Clause	Requirement + Test	Result - Remark	Verdict
19.11.4.8	The appliance is supplied at rated voltage and operated under normal operation. After 60 s the power supply is reduced to a level such that the appliance ceases to respond or parts controlled by the programmable component cease to operate		N/A
	The appliance continues to operate normally, or		N/A
	requires a manual operation to restart		N/A
19.12	If the safety of the appliance for any of the fault conditions specified in 19.11.2 depends on the operation of a miniature fuse-link complying with IEC 60127, the test is repeated, measuring the current flowing through the fuse-link; measured current (A); rated current of the fuse-link (A)..... :		N/A
19.13	During the tests the appliance does not emit flames, molten metal, poisonous or ignitable gas in hazardous amounts		P
	Temperature rises not exceeding the values shown in Table 9..... :	(see appended table)	P
	Compliance with Clause 8 not impaired		P
	If the appliance can still be operated it complies with 20.2		N/A
	Insulation, other than of class III appliances or class III constructions that do not contain live parts, withstands the electric strength test of 16.3, the test voltage as specified in Table 4:		--
	- basic insulation (V)..... :	1000 V	P
	- supplementary insulation (V)..... :	1750 V	P
	- reinforced insulation (V)..... :	3000 V	P
	After operation or interruption of a control, clearances and creepage distances across the functional insulation withstand the electric strength test of 16.3, the test voltage being twice the working voltage		P
	The appliance does not undergo a dangerous malfunction, and		P
	no failure of protective electronic circuits, if the appliance is still operable		N/A
	Appliances tested with an electronic switch in the OFF position, or in the stand-by mode:		--
	- do not become operational, or		N/A

IEC 60335-2-15			
Clause	Requirement + Test	Result - Remark	Verdict
	- if they become operational, do not result in a dangerous malfunction during or after the tests of 19.11.4		N/A
	If the appliance contains lids or doors that are controlled by one or more interlocks, one of the interlocks may be released provided that:		--
	- the lid or door does not move automatically to an open position when the interlock is released, and		N/A
	- the appliance does not start after the cycle in which the interlock was released		N/A
	During the test of 19.4, protective devices of pressure cookers other than dynamic pressure cookers operate before pressure has reached 350 kPa (IEC 60335-2-15)		N/A
	During the test of 19.4, protective devices or intentionally weak parts of dynamic pressure cookers operate before pressure has reached 250 kPa (IEC 60335-2-15)		N/A
	Temperature rise of windings of induction rice cookers not exceeding the values specified in 19.7 (IEC 60335-2-15)		N/A
	Induction rice cookers: electric strength test carried out immediately after switching off the appliance (IEC 60335-2-15)		N/A
19.14	Appliances operated under the conditions of Clause 11, any contactor or relay contact operating under the conditions of Clause 11 being short-circuited		N/A
	For a relay or contactor with more than one contact, all contacts are short-circuited at the same time		N/A
	A relay or contactor operating only to ensure the appliance is energized for normal use is not short-circuited		N/A
	If more than one relay or contactor operates in Clause 11, they are short-circuited in turn		N/A
19.15	For appliances with a mains voltage selector switch, the switch is set to the lowest rated voltage position and the highest value of rated voltage is applied		N/A
19.101	Kettles operated empty at 0,85 times or 1,15 times rated power input, whichever is more unfavourable, with thermal cut-out that operates during the test of 19.4 short circuited (IEC 60335-2-15)		P

IEC 60335-2-15			
Clause	Requirement + Test	Result - Remark	Verdict
	During the test, any flames keep within the enclosure of the kettle and supporting surface does not ignite		P
	After the test, and when the insulation has cooled down to approximately room temperature, live parts shall not be accessible and the kettle shall pass the dielectric strength test in 16.3 with the test voltage specified in Table 4 (IEC 60335-2-15, AMD2)		P
	The humidity treatment of 15.3 is not applied before the electric strength test is carried out (IEC 60335-2-15, AMD2)		P
	The kettle is filled to its rated capacity with water for 24 h before the electric strength test is carried out. Other requirements of 19.13 are not applicable (IEC 60335-2-15, AMD2)		P
19.102	Kettles are placed on a plywood board having a thickness of approximately 20 mm (IEC 60335-2-15, AMD1)		P
	Kettles incorporating two self-resetting thermal cut-outs operated with one of the thermal cut-out short circuited, empty at 0,85 or 1,15 times rated power input, whichever is most unfavourable (IEC 60335-2-15)		P
	Within 2 s of the thermal cut-out operating, the kettle is filled with water having a temperature of 15 °C ± 5 °C. After 1 min, the kettle is emptied		P
	The test is carried out 100 times		P
19.103	Appliances with detachable liquid containers: automatic transfer of liquid from one container to another is liable and safe (IEC 60335-2-15)		N/A
	Compliance is checked by the test as specified		N/A
	After the test, the appliance withstands the tests of 16.3, and		N/A
	no trace of water on insulation which can result in reduction of creepage distances and clearances below values specified in Clause 29		N/A
19.104	The overloading of a soy milk maker does not result in a hazard (IEC 60335-2-15)		N/A
	Compliance is checked by the test as specified		N/A
	During the test, any flames keep within the enclosure and supporting surface does not ignite		N/A
	After the test, live parts not be accessible		N/A

IEC 60335-2-15			
Clause	Requirement + Test	Result - Remark	Verdict
19.105	When a soy milk maker is disconnected from the supply accidentally during normal use, it does not result in a hazard (IEC 60335-2-15)		N/A
	Compliance is checked by the test as specified		N/A
	During the test, any flames keep within the enclosure and supporting surface does not ignite		N/A
	After the test, live parts not be accessible		N/A
19.106	The appliance is operated at rated power input with the heated surface completely covered with two layers of textile material of pre-washed double-hemmed cotton sheets until steady conditions are established (IEC 60335-2-15, AMD1)		N/A
	If a thermostat operates, the test is repeated with the one-third of the heated surface furthest from the temperature-sensing element covered (IEC 60335-2-15, AMD1)		N/A
	The textile material shall not ignite (IEC 60335-2-15, AMD1)		N/A
19.107	Coffee-makers with a decorative door or intended to be used in a cabinet are operated under the conditions specified in Clause 11 but with the decorative door or cabinet door closed (IEC 60335-2-15, AMD1)		N/A
19.108	Automatic coffee-makers of the coffee bean type, other than automatic espresso coffee-makers of the coffee bean type, are supplied at rated voltage and operated under normal operation five times with rest periods (IEC 60335-2-15, AMD1)		N/A
	Automatic espresso coffee-makers of the coffee bean type are supplied at rated voltage and are set to maximum quantity of coffee powder, with smallest amount of coffee in the cup according to the instructions without rest periods (IEC 60335-2-15, AMD1)		N/A
	The duration of the operating period is (IEC 60335-2-15, AMD1)		--
	– for appliances incorporating a timer, the longest period allowed by the timer;		N/A
	– for other appliances, as follows:		N/A
	• for automatic coffee-makers incorporating coffee mills of the grinding type, 30 s longer than the time needed to fill the collecting container or the time required to empty the hopper, whichever is shorter;		N/A

IEC 60335-2-15			
Clause	Requirement + Test	Result - Remark	Verdict
	• for automatic coffee-makers incorporating other coffee mills, 1 min		N/A
	The duration of the rest period for is (IEC 60335-2-15, AMD1)		--
	– 10 s, for appliances provided with a collecting container;		N/A
	– 60 s, for other appliances		N/A
	The temperature of the windings shall not exceed the values shown in Table 8 (IEC 60335-2-15, AMD1)		N/A
20	STABILITY AND MECHANICAL HAZARDS		--
20.1	Appliances having adequate stability		P
	Tilting test through an angle of 10°, appliance placed on an inclined plane/horizontal support, not connected to the supply mains; appliance does not overturn		P
	Tilting test repeated on appliances with heating elements, angle of inclination increased to 15°	Not overturn	P
	Possible heating test in overturned position; temperature rise does not exceed values shown in Table 9		N/A
20.2	Moving parts adequately arranged or enclosed as to provide protection against personal injury		N/A
	Protective enclosures, guards and similar parts are non-detachable, and		N/A
	have adequate mechanical strength		N/A
	Enclosures that can be opened by overriding an interlock are considered to be detachable parts		N/A
	Self-resetting thermal cut-outs and overcurrent protective devices not causing a hazard by unexpected closure		N/A
	Not possible to touch dangerous moving parts with the test probe described		N/A
20.101	The container and cutting blades of soy milk makers have adequate mechanical strength (IEC 60335-2-15)		N/A
	Compliance is checked by the test as specified		N/A
	Container and cutting blades not broken		N/A
20.102	The rotating parts of soy milk makers not become loose during operation (IEC 60335-2-15)		N/A

IEC 60335-2-15			
Clause	Requirement + Test	Result - Remark	Verdict
	Compliance is checked by inspection and manual test as specified		N/A
	Fastening of screws and nuts in a direction opposite to the direction of rotation of the rotating parts considered to be a suitable means of securing the rotating parts		N/A
20.103	For soy milk makers: lid interlock, if any, constructed so that accidental operation of the appliance is prevented (IEC 60335-2-15)		N/A
	Lid interlock switches are biased-off switches		N/A
	If there is an interlock between the lid and the main switch, the lid is locked when the switch is in the on position		N/A
	When the lid is not correctly closed, the switch is locked in the OFF position		N/A
	Compliance is checked by inspection, by manual test and by applying test probe B of IEC 61032		N/A
21	MECHANICAL STRENGTH		--
21.1	Appliance has adequate mechanical strength and is constructed as to withstand rough handling		P
	Checked by applying 3 blows to every point of the enclosure like to be weak, in accordance with test Ehb of IEC 60068-2-75, spring hammer test, with an impact energy of 0,5 J	(see appended table)	P
	The appliance shows no damage impairing compliance with this standard, and		P
	compliance with 8.1, 15.1 and Clause 29 not impaired		P
	If doubt, supplementary or reinforced insulation subjected to the electric strength test of 16.3		N/A
	If necessary, repetition of groups of three blows on a new sample		N/A
	Breakage of glass parts is neglected provided that compliance with 8.1, 15.1 and 15.101 is not impaired (IEC 60335-2-15)		N/A
21.2	Accessible parts of solid insulation having strength to prevent penetration by sharp implements		P
	Test not applicable if the thickness of supplementary insulation is at least 1 mm and reinforced insulation at least 2 mm		P

IEC 60335-2-15			
Clause	Requirement + Test	Result - Remark	Verdict
	The insulation is tested as specified, and does withstand the electric strength test of 16.3		N/A
22	CONSTRUCTION		--
22.1	Appliance marked with the first numeral of the IP system, relevant requirements of IEC 60529 are fulfilled	IPX0	N/A
22.2	Stationary appliance: means to ensure all-pole disconnection from the supply being provided:		--
	- a supply cord fitted with a plug, or		N/A
	- a switch complying with 24.3, or		N/A
	- a statement in the instruction sheet that a disconnection incorporated in the fixed wiring is to be provided, or		N/A
	- an appliance inlet		N/A
	Single-pole switches and single-pole protective devices for the disconnection of heating elements in single-phase, permanently connected class 0I and class I appliances, connected to the phase conductor		N/A
22.3	Appliance provided with pins: no undue strain on socket-outlets		N/A
	Applied torque not exceeding 0,25 Nm		N/A
	Pull force of 50 N to each pin after the appliance has being placed in the heating cabinet; when cooled to room temperature the pins are not displaced by more than 1 mm		N/A
	Each pin subjected to a torque of 0,4 Nm; the pins are not rotating, unless		N/A
	rotating does not impair compliance with this standard		N/A
22.4	Appliance for heating liquids and appliance causing undue vibration not provided with pins for insertion into socket-outlets		P
22.5	No risk of electric shock when touching pins, for appliances having a capacitor with rated capacitance equal to or greater than 0,1µF, the appliance being disconnected from the supply at the instant of voltage peak		N/A
	Voltage not exceeding 34 V (V)..... :		N/A
	If compliance relies on the operation of an electronic circuit, the electromagnetic phenomena tests of 19.11.4.3 and 19.11.4.4 are applied		N/A

IEC 60335-2-15			
Clause	Requirement + Test	Result - Remark	Verdict
	The discharge test is then repeated three times, voltage not exceeding 34 V (V)		N/A
22.6	Electrical insulation not affected by condensing water or leaking liquid		P
	Electrical insulation of class II appliances not affected if a hose ruptures or seal leaks		N/A
	In case of doubt, test as described		N/A
	Drain holes, at least 5 mm in diameter or 20 mm ² in area with a width of at least 3 mm (IEC 60335-2-15)		P
22.7	Adequate safeguards against the risk of excessive pressure in appliances containing liquid or gases or having steam-producing devices		N/A
	Additional test for espresso coffee-maker: (IEC 60335-2-15, AMD1)		--
	Appliance operated with coffee filter blocked and outlet closed. The maximum pressure attained is measured, then the appliance is subjected to twice the measure pressure for 5 min		N/A
	No rupture, no leakage other than through a self-resetting pressure-relief device or intentionally weak part		N/A
	If a self-resetting pressure relief device operates, the appliance shall be suitable for further use		N/A
	Maximum pressure test with pressure limiting devices made ineffective		N/A
	No explosion nor emission of dangerous jets of steam		N/A
	Last test repeated in case of rupture of an intentionally weak part: the appliance shall be terminated in the same mode		N/A
	All pressure regulating devices and all protective devices and intentionally weak parts are rendered inoperative and the lid is closed		N/A
	For pressure cookers, other than dynamic pressure cookers, the pressure is gradually increased hydraulically to two times the operating pressure of the protective device during the test of 19.4		N/A
	Dynamic pressure cookers: the pressure is gradually increased hydraulically to 50 kPa in excess of the operating pressure of the protective device or intentionally weak part during the test of 19.4		N/A
	No rupture of container		N/A

IEC 60335-2-15			
Clause	Requirement + Test	Result - Remark	Verdict
22.8	Electrical connections not subject to pulling during cleaning of compartments to which access can be gained without the aid of a tool, and that are likely to be cleaned in normal use		P
22.9	Insulation, internal wiring, windings, commutators and slip rings not exposed to oil, grease or similar substances, unless		P
	the substance has adequate insulating properties		N/A
22.10	Not possible to reset voltage-maintained non-self-resetting thermal cut-outs by the operation of an automatic switching device incorporated within the appliance, if:		N/A
	- a non-self-resetting thermal cut-out is required by the standard, and		N/A
	- a voltage maintained non-self-resetting thermal cut-out is used to meet it		N/A
	Non-self-resetting thermal motor protectors have a trip-free action, unless		N/A
	they are voltage maintained		N/A
	Reset buttons of non-self-resetting controls so located or protected that accidental resetting is unlikely		N/A
22.11	Reliable fixing of non-detachable parts that provide the necessary degree of protection against electric shock, moisture or contact with moving parts		P
	Obvious locked position of snap-in devices used for fixing such parts		N/A
	No deterioration of the fixing properties of snap-in devices used in parts that are likely to be removed during installation or servicing		N/A
	Tests as described	Pull: 50 N, push: 50 N	P
22.12	Handles, knobs etc. fixed in a reliable manner, if loosening result in a hazard		P
	Removing or fixing in wrong position of handles, knobs etc. indicating position of switches or similar components not possible, if resulting in a hazard		P
	A choking hazard does not apply to appliances for commercial use		N/A
	Axial force 15 N applied to parts, the shape being so that an axial pull is unlikely to be applied		P
	Axial force 30 N applied to parts, the shape being so that an axial pull is likely to be applied		P

IEC 60335-2-15			
Clause	Requirement + Test	Result - Remark	Verdict
	If the part is removed and can be contained within the small parts cylinder, it is considered to be a choking hazard		N/A
22.13	Unlikely that handles, when gripped as in normal use, make the operator's hand touch parts having a temperature rise exceeding the value specified for handles which are held for short periods only		P
22.14	No ragged or sharp edges creating a hazard for the user in normal use, or during user maintenance		P
	No exposed pointed ends of self-tapping screws or other fasteners, likely to be touched by the user in normal use or during user maintenance		P
22.15	Storage hooks and the like for flexible cords smooth and well rounded		P
22.16	Automatic cord reels cause no undue abrasion or damage to the sheath of the flexible cord, no breakage of conductors strands and no undue wear of contacts		N/A
	Cord reel tested with 6 000 operations, as specified		N/A
	Electric strength test of 16.3, voltage of 1 000 V applied		N/A
22.17	Spacers not removable from the outside by hand or by means of a screwdriver or a spanner		N/A
22.18	Current-carrying parts and other metal parts resistant to corrosion		P
22.19	Driving belts not relied upon to provide the required level of insulation, unless		N/A
	constructed to prevent inappropriate replacement		N/A
22.20	Direct contact between live parts and thermal insulation effectively prevented, unless		N/A
	material used is non-corrosive, non-hygroscopic and non-combustible		N/A
22.21	Wood, cotton, silk, ordinary paper and fibrous or hygroscopic material not used as insulation, unless	No such material	P
	impregnated		N/A
	This requirement does not apply to magnesium oxide and mineral ceramic fibres used for the electrical insulation of heating elements		P
22.22	Appliances not containing asbestos		P
22.23	Oils containing polychlorinated biphenyl (PCB) not used		P

IEC 60335-2-15			
Clause	Requirement + Test	Result - Remark	Verdict
22.24	Bare heating elements, except in class III appliances or class III constructions that do not contain live parts, adequately supported		N/A
	In case of rupture, the heating conductor is unlikely to come in contact with accessible metal parts		N/A
22.25	Sagging heating conductors, except in class III appliances or class III constructions that do not contain live parts, cannot come into contact with accessible metal parts		N/A
22.26	For class III constructions the insulation between parts operating at safety extra-low voltage and other live parts complies with the requirements for double or reinforced insulation		N/A
22.27	Parts connected by protective impedance separated by double or reinforced insulation		N/A
22.28	Metal parts of class II appliances conductively connected to gas pipes or in contact with water, separated from live parts by double or reinforced insulation		N/A
22.29	Class II appliances permanently connected to fixed wiring so constructed that the required degree of access to live parts is maintained after installation		N/A
22.30	Parts serving as supplementary or reinforced insulation fixed so that they cannot be removed without being seriously damaged, or		N/A
	so constructed that they cannot be replaced in an incorrect position, and so that if they are omitted, the appliance is rendered inoperable or manifestly incomplete		P
22.31	Neither clearances nor creepage distances over supplementary and reinforced insulation reduced below values specified in Clause 29 as a result of wear		P
	Neither clearances nor creepage distances between live parts and accessible parts reduced below values for supplementary insulation if wires, screws etc. become loose		P
22.32	Supplementary and reinforced insulation constructed or protected against pollution so that clearances or creepage distances are not reduced below the values in Clause 29		P
	Supplementary insulation of natural or synthetic rubber resistant to ageing, or arranged and dimensioned so that creepage distances are not reduced below values specified in 29.2		N/A

IEC 60335-2-15			
Clause	Requirement + Test	Result - Remark	Verdict
	Ceramic material not tightly sintered, similar materials or beads alone not used as supplementary or reinforced insulation		P
	Ceramic and similar porous material in which heating conductors are embedded is considered to be basic insulation, not reinforced insulation		P
	Oxygen bomb test at 70 °C for 96 h and 16 h at room temperature		N/A
22.33	Conductive liquids that are or may become accessible in normal use and conductive liquids that are in contact with unearthed accessible metal parts are not in direct contact with live parts, or		P
	unearthed metal parts separated from live parts by basic insulation only		N/A
	Electrodes not used for heating liquids		N/A
	For class II constructions, conductive liquids that are or may become accessible in normal use and conductive liquids that are in contact with unearthed accessible metal parts, not in direct contact with basic or reinforced insulation, unless		P
	the reinforced insulation consists of at least 3 layers		N/A
	For class II constructions, conductive liquids which are in contact with live parts, not in direct contact with reinforced insulation, unless		N/A
	the reinforced insulation consists of at least 3 layers		N/A
	An air layer not used as basic or supplementary insulation in a double insulation system if likely to be bridged by leaking liquid		P
22.34	Shafts of operating knobs, handles, levers etc. not live, unless		P
	the shaft is not accessible when the part is removed		N/A
22.35	For other than class III constructions, handles, levers and knobs, held or actuated in normal use, not becoming live in the event of a failure of basic insulation		P
	Such parts being of metal, and their shafts or fixings are likely to become live in the event of a failure of basic insulation, are either adequately covered by insulation material or their accessible parts are separated from their shafts or fixings by supplementary insulation		N/A

IEC 60335-2-15			
Clause	Requirement + Test	Result - Remark	Verdict
	This requirement does not apply to handles, levers and knobs on stationary appliances and cordless appliances, other than those of electrical components, provided they are reliably connected to an earthing terminal or earthing contact, or separated from live parts by earthed metal		N/A
	Insulating material covering metal handles, levers and knobs withstand the electric strength test of 16.3 for supplementary insulation		N/A
22.36	For appliances other than class III, handles continuously held in the hand in normal use so constructed that when gripped as in normal use, the operators hand is not likely to touch metal parts, unless		N/A
	they are separated from live parts by double or reinforced insulation		N/A
22.37	Capacitors in class II appliances not connected to accessible metal parts and their casings, if of metal, separated from accessible metal parts by supplementary insulation, unless		N/A
	the capacitors comply with 22.42		N/A
22.38	Capacitors not connected between the contacts of a thermal cut-out		N/A
22.39	Lampholders used only for the connection of lamps		N/A
22.40	Motor-operated appliances and combined appliances intended to be moved while in operation, or having accessible moving parts, fitted with a switch to control the motor. The actuating member of the switch being easily visible and accessible		N/A
	If the appliance cannot operate continuously, automatically or remotely without giving rise to a hazard, appliances for remote operation being fitted with a switch for stopping the operation. The actuating member of the switch being easily visible and accessible		N/A
	For soy milk makers, any switch controlling the motor also disconnect electronic circuits, if their malfunction would impair compliance with this standard (IEC 60335-2-15)		N/A
	Compliance is checked by the tests of Clause 19 (IEC 60335-2-15)		N/A
22.41	No components, other than lamps, containing mercury		P

IEC 60335-2-15			
Clause	Requirement + Test	Result - Remark	Verdict
22.42	Protective impedance consisting of at least two separate components		N/A
	Values specified in 8.1.4 not exceeded if any one of the components are short-circuited or open-circuited		N/A
	Resistors checked by the test of 14.1 a) in IEC 60065		N/A
	Capacitors checked by the tests for class Y capacitors in IEC 60384-14		N/A
22.43	Appliances adjustable for different voltages, accidental changing of the setting of the voltage unlikely to occur		N/A
22.44	Appliances not having an enclosure that is shaped or decorated like a toy		P
22.45	When air is used as reinforced insulation, clearances not reduced below the values specified in 29.1.3 due to deformation as a result of an external force applied to the enclosure		P
22.46	For programmable protective electronic circuits used to ensure compliance with the standard, the software contains measures to control the fault/error conditions in Table R.1		N/A
	Software that contains measures to control the fault/error conditions specified in Table R.2 is to be specified in parts 2 for particular constructions or to address specific hazards		N/A
	These requirements are not applicable to software used for functional purpose or compliance with Clause 11		N/A
22.47	Appliances connected to the water mains withstand the water pressure expected in normal use		N/A
	No leakage from any part, including any inlet water hose		N/A
22.48	Appliances connected to the water mains constructed to prevent backsiphonage of non-potable water		N/A
22.49	For remote operation, the duration of operation is to be set before the appliance can be started, unless		N/A
	the appliance switches off automatically or can operate continuously without hazard		N/A
22.50	Controls incorporated in the appliance take priority over controls actuated by remote operation		N/A

IEC 60335-2-15			
Clause	Requirement + Test	Result - Remark	Verdict
22.51	There is a control on the appliance manually adjusted to the setting for remote operation before the appliance can be operated in this mode		N/A
	There is a visual indication showing that the appliance is adjusted for remote operation		N/A
	These requirements not necessary on appliances that can operate as follows, without giving rise to a hazard:		--
	- continuously, or		N/A
	- automatically, or		N/A
	- remotely		N/A
22.52	Socket-outlets on appliances accessible to the user in accordance with the socket-outlet system used in the country in which the appliance is sold		N/A
22.53	Class II appliances and class III appliances that incorporate functionally earthed parts have at least double insulation or reinforced insulation between live parts and the functionally earthed parts		N/A
22.54	Button cells and batteries designated R1 not accessible without the aid of a tool, unless		N/A
	the cover of their compartment can only be opened after at least two independent movements have been applied simultaneously		N/A
22.55	Devices operated to stop the intended function of the appliance, if any, are be distinguished from other manual devices by means of shape, size, surface texture or position		P
	The requirement concerning position does not preclude use of a push on push off switch		N/A
	An indication when the device has been operated is given by:		--
	- tactile feedback from the actuator or from the appliance, or		P
	- reduction in heat output; or		N/A
	- audible and visible feedback		N/A
22.56	Detachable power supply part provided with the part of class III construction		N/A
22.57	The properties of non-metallic materials do not degrade from exposure to UV-C radiation, as specified in Annex T		N/A
	This requirement does not apply to glass, ceramics or similar materials		N/A

IEC 60335-2-15			
Clause	Requirement + Test	Result - Remark	Verdict
22.101	Kettles constructed so that the lid does not fall off when water is poured out (IEC 60335-2-15)		P
	Compliance is checked by the test as specified		P
	Lid not fall off and water only emitted from the spout		P
22.102	Kettles so constructed that there are no sudden jets of steam or hot water likely to expose the user to a hazard when the appliance is used as in normal use (IEC 60335-2-15)		P
	Compliance is checked by inspection during the test of Clause 11		P
22.103	Appliance coupler of cordless appliances constructed to withstand the stresses occurring during normal use (IEC 60335-2-15)		P
	Compliance is checked by the test as specified		P
	Appliance is placed on its stand and withdrawn for:		--
	- cordless kettles 10 000 times		P
	- cordless coffee makers 10 000 times		N/A
	- other cordless appliances 6 000 times		N/A
	The test continued without current flowing for a further 10 000 times for cordless kettles and cordless coffee makers, or		P
	6 000 times for other cordless appliances		N/A
	If a single stand is supplied with more than one cordless appliance, the test for each cordless appliance is carried out using the same stand		N/A
	The appliance is suitable for further use and compliance with 8.1, 16.3, 27.5 and Clause 29 not be impaired		P
	The test is carried out without current flowing if the connection contacts cannot make or break on load		N/A
22.104	Portable appliances in which water boil with a container greater than 3 l is filled to its rated capacity with the lid closed in accordance with instructions for use (IEC 60335-2-15)		N/A
	The plane is slowly inclined to an angle of 25°; if the appliance overturns, it is left in this position for 10 s and then returned to its normal position		N/A
	The rate of discharge of liquid does not exceed 16 l/min		N/A

IEC 60335-2-15			
Clause	Requirement + Test	Result - Remark	Verdict
22.105	Fixed appliances for boiling water constructed so that the container is always open to the atmosphere through an aperture of at least 5 mm in diameter or 20 mm ² in area with a width of at least 3 mm (IEC 60335-2-15)		N/A
	Aperture not likely to be obstructed in normal use		N/A
	If the appliance has provisions for discharging steam or water overflowing, the discharge aperture shall be at the base of the appliance and discharge vertically downwards		N/A
	Compliance is checked by inspection and by measurement		N/A
22.106	Espresso coffee-maker: not possible to remove the filter by a simple operation while there is hazardous pressure within the container (IEC 60335-2-15)		N/A
	Compliance is checked by inspection and by manual test		N/A
	This requirement is considered to be met if the coffee filter can only be removed after it has been rotated through an angle of at least 30°		N/A
22.107	Pressure cookers incorporate a non-self-resetting pressure or temperature responsive pressure relief device (IEC 60335-2-15)		N/A
	Compliance is checked by inspection		N/A
22.108	Pressure cooker: not possible to remove the lid when the inner pressure is excessive (IEC 60335-2-15)		N/A
	Pressure test at 4 kPa and 100 N		N/A
	No hazardous displacement of lid at removal		N/A
	Test not carried out on pressure cookers when the lid is secured by screw clamps or other devices that ensure that the pressure is automatically reduced in a controlled manner before the lid can be removed		N/A
22.109	Pressure cookers constructed so that the pressure in the container is not excessive when the lid is not closed or is incorrectly fitted (IEC 60335-2-15)		N/A
	Compliance is checked by the test as specified		N/A
	Pressure not exceeding 4,0 kPa		N/A

IEC 60335-2-15			
Clause	Requirement + Test	Result - Remark	Verdict
22.110	Feeding-bottle heaters with a control to set a pre-determined temperature or time shall emit a visible or audible signal to indicate that the pre-determined temperature or time has been reached (IEC 60335-2-15, AMD2)		N/A
22.111	Espresso coffee-makers, incorporating a pressurized reservoir filled by the user constructed so that there is no spillage of water or sudden jets of steam or hot water (IEC 60335-2-15)		N/A
	When removing the filling cap of the pressurized reservoir, before the cap is removed completely, the pressure relieves in a controlled manner		N/A
	Compliance is checked by inspection during the test of Clause 11 and by removing the filling cap at the end of the test		N/A
22.112	Soy milk makers constructed so that steam or hot water are not ejected which may expose the user to a hazard (IEC 60335-2-15)		N/A
	Compliance is checked by inspection		N/A
22.113	Appliances with moving mechanical parts constructed so that lubricants are prevented from polluting food compartments (IEC 60335-2-15)		N/A
	Compliance is checked by inspection		N/A
22.114	Appliances constructed so that food or liquids are prevented from penetrating into places that could cause electrical or mechanical faults (IEC 60335-2-15)		P
	Compliance is checked by inspection		P
22.115	Coffee-makers shall be constructed so that it is not possible to rotate the frothing nozzle or hot water nozzle through an angle of more than 45° upwards from the downwards facing vertical position (IEC 60335-2-15, AMD1)		N/A
	Compliance is checked by inspection and by manual test		N/A
23	INTERNAL WIRING		--
23.1	Wireways smooth and free from sharp edges		P
	Wires protected against contact with burrs, cooling fins etc.		P
	Wire holes in metal well-rounded or provided with bushings		P

IEC 60335-2-15			
Clause	Requirement + Test	Result - Remark	Verdict
	Wiring effectively prevented from coming into contact with moving parts		N/A
23.2	Beads etc. on live wires cannot change their position, and are not resting on sharp edges		N/A
	Beads inside flexible metal conduits contained within an insulating sleeve		N/A
23.3	Electrical connections and internal conductors movable relatively to each other not exposed to undue stress		N/A
	Flexible metallic tubes not causing damage to insulation of conductors		N/A
	Open-coil springs not used		N/A
	Adequate insulating lining provided inside a coiled spring, the turns of which touch one another		N/A
	No damage after 10 000 flexings for conductors flexed during normal use, or		N/A
	100 flexings for conductors flexed during user maintenance		N/A
	Electric strength test of 16.3, 1 000 V between live parts and accessible metal parts		N/A
	Not more than 10 % of the strands of any conductor broken, and		N/A
	not more than 30 % for wiring supplying circuits that consume no more than 15 W		N/A
23.4	Bare internal wiring sufficiently rigid and fixed		N/A
23.5	The insulation of internal wiring subjected to the supply mains voltage withstanding the electrical stress likely to occur in normal use		P
	Basic insulation electrically equivalent to the basic insulation of cords complying with IEC 60227 or IEC 60245, or		N/A
	no breakdown when a voltage of 2 000 V is applied for 15 min between the conductor and metal foil wrapped around the insulation		P
	For class II construction, the requirements for supplementary insulation and reinforced insulation apply, except		N/A
	that the sheath of a cord complying with IEC 60227 or IEC 60245 may provide supplementary insulation		N/A

IEC 60335-2-15			
Clause	Requirement + Test	Result - Remark	Verdict
	A single layer of internal wiring insulation does not provide reinforced insulation		P
23.6	Sleeving used as supplementary insulation on internal wiring retained in position by clamping at both ends, or		N/A
	be such that it can only be removed by breaking or cutting		N/A
23.7	The colour combination green/yellow only used for earthing conductors		P
23.8	Aluminium wires not used for internal wiring		P
23.9	Stranded conductors not consolidated by soldering where they are subjected to contact pressure, unless		P
	the contact pressure is provided by spring terminals		N/A
23.10	The insulation and sheath of internal wiring, incorporated in external hoses for the connection of an appliance to the water mains, at least equivalent to that of light polyvinyl chloride sheathed flexible cord (60227 IEC 52)		N/A
24	COMPONENTS		--
24.1	Components comply with safety requirements in relevant IEC standards		P
	List of components :	(see appended table)	P
	Motors not required to comply with IEC 60034-1, they are tested as part of the appliance		N/A
	Relays tested as part of the appliance, or		N/A
	alternatively according to IEC 60730-1, and meeting the additional requirements in IEC 60335-1		N/A
	The requirements of Clause 29 apply between live parts of components and accessible parts of the appliance		P
	Components can comply with the requirements for clearances and creepage distances for functional insulation in the relevant component standard		P
	30.2 of this standard apply to parts of non-metallic material in components including parts of non-metallic material supporting current-carrying connections		P
	Components that have not been previously tested to comply with the IEC standard for the relevant component are tested according to the requirements of 30.2		P

IEC 60335-2-15			
Clause	Requirement + Test	Result - Remark	Verdict
	Components that have been previously tested to comply with the resistance to fire requirements in the IEC standard for the relevant component need not be retested provided the specified conditions are met		P
	If these conditions are not satisfied, the component is tested as part of the appliance		P
	Power electronic converter circuits not required to comply with IEC 62477-1, they are tested as part of the appliance		N/A
	If components have not been tested and found to comply with relevant IEC standard for the number of cycles specified, they are tested in accordance with 24.1.1 to 24.1.9		P
	For components mentioned in 24.1.1 to 24.1.9 no additional tests specified in the relevant component standard are necessary other than those specified in 24.1.1 to 24.1.9		P
	Components not tested and found to comply with relevant IEC standard and components not marked or not used in accordance with its marking, tested under the conditions occurring in the appliance		P
	Lampholders and starterholders that have not being tested and found to comply with the relevant IEC standard, tested as a part of the appliance and additionally according to the gauging and interchangeability requirements of the relevant IEC standard		N/A
	No additional tests specified for nationally standardized plugs such as those detailed in IEC/TR 60083 or connectors complying with the standard sheets of IEC 60320-1 and IEC 60309		P
24.1.1	Capacitors likely to be permanently subjected to the supply voltage and used for radio interference suppression or for voltage dividing, comply with IEC 60384-14		N/A
	If the capacitors have to be tested, they are tested according to Annex F		N/A
24.1.2	Transformers in associated switch mode power supplies comply with Annex BB of IEC 61558-2-16		N/A
	Safety isolating transformers comply with IEC 61558-2-6		N/A
	If they have to be tested, they are tested according to Annex G		N/A

IEC 60335-2-15			
Clause	Requirement + Test	Result - Remark	Verdict
24.1.3	Switches comply with IEC 61058-1, the number of cycles of operation being at least 10 000		N/A
	If they have to be tested, they are tested according to Annex H		N/A
	If the switch operates a relay or contactor, the complete switching system is subjected to the test		N/A
	If the switch only operates a motor starting relay complying with IEC 60730-2-10 with the number of cycles of a least 10 000 as specified, the complete switching system need not be tested		N/A
	Switches incorporated in espresso coffee-makers for initiating brewing or steaming tested for 10 000 cycles (IEC 60335-2-15)		N/A
	Switches incorporated in dynamic pressure cookers for controlling heaters are subjected to 50 000 cycles of operation and are tested under the conditions of Clause 11 with the appliance supplied at rated voltage (IEC 60335-2-15)		N/A
24.1.4	Automatic controls comply with IEC 60730-1 with the relevant part 2. The number of cycles of operation being at least:		--
	- thermostats:	10 000	N/A
	- temperature limiters:	1 000	P
	- self-resetting thermal cut-outs:	300	P
	- voltage maintained non-self-resetting thermal cut-outs:	1 000	N/A
	- other non-self-resetting thermal cut-outs:	30	N/A
	- timers:	3 000	N/A
	- energy regulators:	10 000	N/A
	The number of cycles for controls operating during Clause 11 need not be declared, if the appliance meets the requirements of this standard when they are short-circuited		N/A
	Thermal motor protectors are tested in combination with their motor under the conditions specified in Annex D		N/A
	For water valves containing live parts and that are incorporated in external hoses for connection of an appliance to the water mains, the degree of protection declared for Subclause 6.5.2 of IEC 60730-2-8 is IPX7		N/A

IEC 60335-2-15			
Clause	Requirement + Test	Result - Remark	Verdict
	Thermal cut-outs of the capillary type comply with the requirements for type 2.K controls in IEC 60730-2-9		N/A
	Self-resetting thermal cut-outs required for compliance with the test of 19.101 are subjected to 3 000 cycles of operation (IEC 60335-2-15)		P
24.1.5	Appliance couplers comply with IEC 60320-1		P
	However, for class II appliances classified higher than IPX0, the appliance couplers comply with IEC 60320-2-3		N/A
	Interconnection couplers comply with IEC 60320-2-2		N/A
	Appliance couplers incorporating thermostats, thermal cut-outs or fuses in the connectors comply with IEC 60320-1, except that: (IEC 60335-2-15)		N/A
	- the earthing contact of connector is allowed to be accessible, if contact is not likely to be gripped during insertion or withdrawal of the connector;		N/A
	- the temperature required for the test of Clause 18 is that measured on the pins of the appliance inlet during test of Clause 11 of this standard;		N/A
	- the breaking-capacity test of Clause 19 carried out using the inlet of the appliance;		N/A
	- the temperature rise of current-carrying parts specified in Clause 21 not determined		N/A
	Thermal controls are not allowed in connectors complying with the standard sheets of IEC 60320-1 (IEC 60335-2-15)		N/A
24.1.6	Small lampholders similar to E10 lampholders comply with IEC 60238, the requirements for E10 lampholders being applicable		N/A
24.1.7	For remote operation of the appliance via a telecommunication network, the relevant standard for the telecommunication interface circuitry in the appliance is IEC 62151		N/A
24.1.8	The relevant standard for thermal links is IEC 60691		N/A
	Thermal links not complying with IEC 60691 are considered to be an intentionally weak part for the purposes of Clause 19		N/A
24.1.9	Contactors and relays, other than motor starting relays, tested as part of the appliance		N/A

IEC 60335-2-15			
Clause	Requirement + Test	Result - Remark	Verdict
	They are also tested in accordance with Clause 17 of IEC 60730-1, the number of cycles of operations in 24.1.4 selected according to the contactor or relay function in the appliance..... :		N/A
24.2	Appliances not fitted with:		--
	- switches, automatic controls or power supplies in flexible cords;		P
	- devices causing the protective device in the fixed wiring to operate in the event of a fault in the appliance;		P
	- thermal cut-outs that can be reset by soldering, unless		P
	the solder has a melting point of at least 230 °C		N/A
24.3	Switches intended for all-pole disconnection of stationary appliances are directly connected to the supply terminals and have a contact separation in all poles, providing full disconnection under overvoltage category III conditions		N/A
24.4	Plugs and socket-outlets for extra-low voltage circuits and heating elements, not interchangeable with plugs and socket-outlets listed in IEC/TR 60083 or IEC 60906-1 or with connectors and appliance inlets complying with the standard sheets of IEC 60320-1		N/A
	Not applicable to the connection between the appliance and the stand of cordless appliances (IEC 60335-2-15)		N/A
24.5	Capacitors in auxiliary windings of motors marked with their rated voltage and capacitance, and used accordingly		N/A
	Voltage across capacitors in series with a motor winding does not exceed 1,1 times rated voltage, when the appliance is supplied at 1,1 times rated voltage under minimum load		N/A
24.6	Working voltage of motors connected to the supply mains and having basic insulation that is inadequate for the rated voltage of the appliance, not exceeding 42 V		N/A
	In addition, the motors comply with the requirements of Annex I		N/A
24.7	Detachable hose-sets for connection of appliances to the water mains comply with IEC 61770		N/A
	They are supplied with the appliance		N/A

IEC 60335-2-15			
Clause	Requirement + Test	Result - Remark	Verdict
	Appliances intended to be permanently connected to the water mains not connected by a detachable hose-set		N/A
24.8	Motor running capacitors in appliances for which 30.2.3 is applicable and that are permanently connected in series with a motor winding, not causing a hazard in event of a failure		N/A
	One or more of the following conditions are to be met:		--
	- the capacitors are of class S2 or S3 according to IEC 60252-1;		N/A
	- the capacitors are housed within a metallic or ceramic enclosure;		N/A
	- the distance of separation of the outer surface to adjacent non-metallic parts exceeds 50 mm;		N/A
	- adjacent non-metallic parts within 50 mm withstand the needle-flame test of Annex E;		N/A
	- adjacent non-metallic parts within 50 mm classified as at least V-1 according to IEC 60695-11-10		N/A
24.101	Devices incorporated in appliance, other than kettles, in order to comply with 19.4 are non-self-resetting (IEC 60335-2-15)		N/A
	However, self-resetting thermal cut-outs are allowed for fixed water boilers, if they have been tested for 10 000 cycles of operation		N/A
	Compliance is checked by inspection and during the test of 19.4		N/A
	If appliances, other than: (IEC 60335-2-15, AMD2)		--
	– fixed water boilers incorporating self-resetting thermal cut-outs that have been subjected to 10 000 cycles of operation, and		N/A
	– kettles		P
	incorporate self-resetting thermal cut-outs, these shall be short-circuited or rendered inoperative for the test of 19.4		N/A
25	SUPPLY CONNECTION AND EXTERNAL FLEXIBLE CORDS		--
25.1	Appliance not intended for permanent connection to fixed wiring, means for connection to the supply:		--
	- supply cord fitted with a plug, the current rating and voltage rating of the plug being not less than the corresponding ratings of its associated appliance;		P

IEC 60335-2-15			
Clause	Requirement + Test	Result - Remark	Verdict
	- an appliance inlet having at least the same degree of protection against moisture as required for the appliance, or		N/A
	- pins for insertion into socket-outlets		N/A
	Appliances incorporating an appliance inlet other than those standardized in IEC 60320-1 are supplied with a cord set (IEC 60335-2-15)		N/A
25.2	Appliance not provided with more than one means of connection to the supply mains		P
	Stationary appliance for multiple supply may be provided with more than one means of connection, provided electric strength test of 1 250 V for 1 min between each means of connection causes no breakdown		N/A
25.3	Appliance intended to be permanently connected to fixed wiring provided with one of the following means for connection to the supply mains:		--
	- a set of terminals allowing the connection of a flexible cord;		N/A
	- a fitted supply cord;		N/A
	- a set of supply leads accommodated in a suitable compartment;		N/A
	- a set of terminals for the connection of cables of fixed wiring, cross-sectional areas specified in 26.6, and the appliance allows the connection of the supply conductors after the appliance has been fixed to its support;		N/A
	- a set of terminals and cable entries, conduit entries, knock-outs or glands, allowing connection of appropriate types of cable or conduit, and the appliance allows the connection of the supply conductors after the appliance has been fixed to its support		N/A
	For a fixed appliance constructed so that parts can be removed to facilitate easy installation, this requirement is met if it is possible to connect the fixed wiring without difficulty after a part of the appliance has been fixed to its support		N/A
25.4	Cable and conduit entries, rated current of appliance not exceeding 16 A, dimension according to Table 10 (mm) :		N/A
	Introduction of conduit or cable does not reduce clearances or creepage distances below values specified in Clause 29		N/A

IEC 60335-2-15			
Clause	Requirement + Test	Result - Remark	Verdict
25.5	Method for assembling the supply cord to the appliance:		--
	- type X attachment		N/A
	- type Y attachment		P
	- type Z attachment, if allowed in relevant part 2		N/A
	Type Z attachment is allowed for egg boilers, feeding bottle heaters, yoghurt makers and stands of cordless appliances (IEC 60335-2-15)		N/A
	Type X attachment, other than those with a specially prepared cord, not used for flat twin tinsel cords		N/A
	For multi-phase appliances supplied with a supply cord and that are intended to be permanently connected to fixed wiring, the supply cord is assembled to the appliance by type Y attachment		N/A
25.6	Plugs fitted with only one flexible cord		P
25.7	Supply cords, other than for class III appliances, being one of the following types:		--
	- rubber sheathed (at least 60245 IEC 53)		N/A
	- polychloroprene sheathed (at least 60245 IEC 57)		N/A
	- polyvinyl chloride sheathed. Not used if they are likely to touch metal parts having a temperature rise exceeding 75 K during the test of Clause 11		--
	<ul style="list-style-type: none"> light polyvinyl chloride sheathed cord (60227 IEC 52), for appliances not exceeding 3 kg; 	H05VV-F or H03VV-F	P
	<ul style="list-style-type: none"> ordinary polyvinyl chloride sheathed cord (60227 IEC 53), for other appliances 		N/A
	- heat resistant polyvinyl chloride sheathed. Not used for type X attachment other than specially prepared cords		--
	<ul style="list-style-type: none"> heat-resistant light polyvinyl chloride sheathed cord (60227 IEC 56), for appliances not exceeding 3 kg; 		N/A
	<ul style="list-style-type: none"> heat-resistant polyvinyl chloride sheathed cord (60227 IEC 57), for other appliances 		N/A
	- halogen-free, low smoke, thermoplastic insulated and sheathed		--
	<ul style="list-style-type: none"> Light duty halogen-free low smoke flexible cable (62821 IEC 101) for circular cable and (62821 IEC 101f) for flat cable 		N/A
	<ul style="list-style-type: none"> Ordinary duty halogen-free low smoke flexible cable (62821 IEC 102) for circular cable and (62821 IEC 102f) for flat cable 		N/A

IEC 60335-2-15			
Clause	Requirement + Test	Result - Remark	Verdict
	Supply cords for class III appliances adequately insulated		N/A
	Test with 500 V for 2 min for supply cords of class III appliances that contain live parts		N/A
	Supply cord of livestock feed boilers are polychloroprene sheathed (IEC 60335-2-15)		N/A
25.8	Nominal cross-sectional area of supply cords not less than Table 11; rated current (A); cross-sectional area (mm ²)	Max. rated Current: 7,8A 3G 0,75mm ² (Length<2m) or 3G 1,0mm ²	P
	Portable appliances having a rated current of up to 10 A may incorporate a supply cord having a nominal cross-sectional area of 0,75 mm ² , if the length is less than 2 m (IEC 60335-2-15)		P
25.9	Supply cords not in contact with sharp points or edges		P
25.10	Supply cord of class I appliances have a green/yellow core for earthing		P
	In multi-phase appliances, the colour of the neutral conductor of the supply cord is blue		N/A
	Where additional neutral conductors are provided in the supply cord:		--
	– other colours may be used for these additional neutral conductors;		N/A
	– all of the neutral conductors and line conductors are identified by marking using the alpha numeric notation specified in IEC 60445		N/A
	– the supply cord is fitted to the appliance		N/A
25.11	Conductors of supply cords not consolidated by soldering where they are subject to contact pressure, unless		P
	the contact pressure is provided by spring terminals		N/A
25.12	Insulation of the supply cord not damaged when moulding the cord to part of the enclosure		P
25.13	Inlet openings so constructed as to prevent damage to the supply cord		P
	If it is not evident that the supply cord can be introduced without risk of damage, a non-detachable lining or bushing complying with 29.3 for supplementary insulation provided		N/A
	If unsheathed supply cord, a similar additional bushing or lining is required, unless the appliance is		N/A
	class 0, or		N/A

IEC 60335-2-15			
Clause	Requirement + Test	Result - Remark	Verdict
	a class III appliance not containing live parts		N/A
25.14	Supply cords moved while in operation adequately protected against excessive flexing		N/A
	Flexing test, as described:		--
	- applied force (N)..... :		N/A
	- number of flexings..... :		N/A
	The test does not result in:		--
	- short-circuit between the conductors, such that the current exceeds a value of twice the rated current;		N/A
	- breakage of more than 10 % of the strands of any conductor;		N/A
	- separation of the conductor from its terminal;		N/A
	- loosening of any cord guard;		N/A
	- damage to the cord or the cord guard;		N/A
	- broken strands piercing the insulation and becoming accessible		N/A
25.15	For appliances with supply cord and appliances to be permanently connected to fixed wiring by a flexible cord, conductors of the supply cord relieved from strain, twisting and abrasion by use of cord anchorage		P
	The cord cannot be pushed into the appliance to such an extent that the cord or internal parts of the appliance can be damaged		P
	Pull and torque test of supply cord:		--
	- fixed appliances: pull 100 N; torque (not on automatic cord reel) (Nm)..... :		N/A
	- other appliances: values shown in Table 12: mass (kg); pull (N); torque (not on automatic cord reel) (Nm)..... :		P
	Cord not damaged and max. 2 mm displacement of the cord		P
25.16	Cord anchorages for type X attachments constructed and located so that:		--
	- replacement of the cord is easily possible;		N/A
	- it is clear how the relief from strain and the prevention of twisting are obtained;		N/A
	- they are suitable for different types of supply cord;		N/A

IEC 60335-2-15			
Clause	Requirement + Test	Result - Remark	Verdict
	- cord cannot touch the clamping screws of cord anchorage if these screws are accessible, unless		N/A
	they are separated from accessible metal parts by supplementary insulation;		N/A
	- the cord is not clamped by a metal screw which bears directly on the cord;		N/A
	- at least one part of the cord anchorage securely fixed to the appliance, unless		N/A
	it is part of a specially prepared cord;		N/A
	- screws which have to be operated when replacing the cord do not fix any other component, unless		N/A
	the appliance becomes inoperative or incomplete or the parts cannot be removed without a tool;		N/A
	- if labyrinths can be bypassed the test of 25.15 is nevertheless withstood;		N/A
	- for class 0, 0I and I appliances they are of insulating material or are provided with an insulating lining, unless		N/A
	failure of the insulation of the cord does not make accessible metal parts live;		N/A
	- for class II appliances they are of insulating material, or		N/A
	if of metal, they are insulated from accessible metal parts by supplementary insulation		N/A
	After the test of 25.15, under the conditions specified, the conductors have not moved by more than 1 mm in the terminals		N/A
25.17	Adequate cord anchorages for type Y and Z attachment, test with the cord supplied with the appliance		P
25.18	Cord anchorages only accessible with the aid of a tool, or		P
	constructed so that the cord can only be fitted with the aid of a tool		N/A
25.19	Type X attachment, glands not used as cord anchorage in portable appliances		N/A
	Tying the cord into a knot or tying the cord with string not used		N/A
25.20	The conductors of the supply cord for type Y and Z attachment insulated from accessible metal parts		P

IEC 60335-2-15			
Clause	Requirement + Test	Result - Remark	Verdict
25.21	Space for supply cord for type X attachment or for connection of fixed wiring constructed:		--
	- to permit checking of conductors with respect to correct positioning and connection before fitting any cover;		N/A
	- so there is no risk of damage to the conductors or their insulation when fitting the cover;		N/A
	- for portable appliances, so that the uninsulated end of a conductor, if it becomes free from the terminal, prevented from contact with accessible metal parts		N/A
	2 N test to the conductor for portable appliances; no contact with accessible metal parts		N/A
25.22	Appliance inlets:		--
	- live parts not accessible during insertion or removal		N/A
	Requirement not applicable to appliance inlets complying with IEC 60320-1;		N/A
	- connector can be inserted without difficulty;		N/A
	- the appliance is not supported by the connector;		N/A
	- not for cold conditions if temperature rise of external metal parts exceeds 75 K during Clause 11, unless		N/A
	the supply cord is unlikely to touch such metal parts		N/A
	Soy milk maker inlets located so that pollution by soy milk is unlikely to occur during normal use (IEC 60335-2-15)		N/A
25.23	Interconnection cords comply with the requirements for the supply cord, except that:		--
	- the cross-sectional area of the conductors is determined on the basis of the maximum current during Clause 11		N/A
	- the thickness of the insulation may be reduced		N/A
	- for class I or class II appliance with class III construction, the cross sectional areas of the conductors need not comply with 25.8 if specified conditions are met		N/A
	If necessary, electric strength test of 16.3		N/A
25.24	Interconnection cords not detachable without the aid of a tool if compliance with this standard is impaired when they are disconnected		N/A

IEC 60335-2-15			
Clause	Requirement + Test	Result - Remark	Verdict
25.25	Dimensions of pins that are inserted into socket-outlets compatible with the dimensions of the relevant socket-outlet		N/A
	Dimensions of pins and engagement face in accordance with the dimensions of the relevant plug in IEC/TR 60083		N/A
25.101	Supply cords of kettles are not longer than 75 cm, unless they are helically coiled (IEC 60335-2-15)		P
	If a cordless kettle has a cord storage facility, the length of the cord is measured after storing as much of the cord as possible		P
	The length of the cord is measured between the plug and the point where the cord or cord guard enters the appliance		P
26	TERMINALS FOR EXTERNAL CONDUCTORS		--
26.1	Appliances provided with terminals or equally effective devices for connection of external conductors		P
	Terminals only accessible after removal of a non-detachable cover, except		P
	for class III appliances that do not contain live parts		N/A
	Earthing terminals may be accessible if a tool is required to make the connections and means are provided to clamp the wire independently from its connection		N/A
26.2	Appliances with type X attachment and appliances for the connection of cables to fixed wiring provided with terminals in which connections are made by means of screws, nuts or similar devices, unless		N/A
	the connections are soldered		N/A
	Screws and nuts not used to fix any other component, except		N/A
	internal conductors, if so arranged that they are unlikely to be displaced when fitting the supply conductors		N/A
	If soldered connections used, the conductor so positioned or fixed that reliance is not placed on soldering alone, unless		N/A

IEC 60335-2-15			
Clause	Requirement + Test	Result - Remark	Verdict
	barriers provided so that neither clearances nor creepage distances between live parts and other metal parts reduced below the values for supplementary insulation if the conductor becomes free at the soldered joint		N/A
26.3	Terminals for type X attachment and for connection of cables of fixed wiring so constructed that the conductor is clamped between metal surfaces with sufficient contact pressure but without damaging the conductor		N/A
	Terminals fixed so that when the clamping means is tightened or loosened:		--
	- the terminal does not become loose;		N/A
	- internal wiring is not subjected to stress;		N/A
	- neither clearances nor creepage distances are reduced below the values in Clause 29		N/A
	Compliance checked by inspection and by the test of Subclause 9.6 of IEC 60999-1, the torque applied being equal to two-thirds of the torque specified (Nm) :		N/A
	No deep or sharp indentations of the conductors		N/A
26.4	Terminals for type X attachment, except those having a specially prepared cord and those for the connection of cables of fixed wiring, no special preparation of conductors such as by soldering, use of cable lugs, eyelets or similar, and		N/A
	so constructed or placed that conductors prevented from slipping out when clamping screws or nuts are tightened		N/A
26.5	Terminals for type X attachment so located or shielded that if a wire of a stranded conductor escapes, no risk of accidental connection to other parts that result in a hazard		N/A
	Stranded conductor test, 8 mm insulation removed		N/A
	No contact between live parts and accessible metal parts and,		N/A
	for class II constructions, between live parts and metal parts separated from accessible metal parts by supplementary insulation only		N/A
26.6	Terminals for type X attachment and for connection of cables of fixed wiring suitable for connection of conductors with cross-sectional area according to Table 13; rated current (A); nominal cross-sectional area (mm ²)..... :		N/A

IEC 60335-2-15			
Clause	Requirement + Test	Result - Remark	Verdict
	If a specially prepared cord is used, terminals need only be suitable for that cord		N/A
26.7	Terminals for type X attachment, except in class III appliances not containing live parts, accessible after removal of a cover or part of the enclosure		N/A
26.8	Terminals for the connection of fixed wiring, including the earthing terminal, located close to each other		N/A
26.9	Terminals of the pillar type constructed and located as specified		N/A
26.10	Terminals with screw clamping and screwless terminals not used for flat twin tinsel cords, unless		N/A
	conductors ends fitted with means suitable for screw terminals		N/A
	Pull test of 5 N to the connection		P
26.11	For type Y and Z attachment, soldered, welded, crimped or similar connections may be used		P
	For class II appliances, the conductor so positioned or fixed that reliance is not placed on soldering, welding or crimping alone		N/A
	If soldering, welding or crimping alone used, barriers provided so that clearances and creepage distances between live parts and other metal parts are not reduced below the values for supplementary insulation if the conductor becomes free		N/A
27	PROVISION FOR EARTHING		--
27.1	Accessible metal parts of class 0I and I appliances permanently and reliably connected to an earthing terminal or earthing contact of the appliance inlet	Class I	P
	Earthing terminals and earthing contacts not connected to the neutral terminal		P
	Class 0, II and III appliances have no provision for protective earthing		N/A
	Class II appliances and class III appliances can incorporate an earth for functional purposes		N/A
	Safety extra-low voltage circuits not earthed, unless		N/A
	protective extra-low voltage circuits		N/A
27.2	Clamping means of earthing terminals adequately secured against accidental loosening		P

IEC 60335-2-15			
Clause	Requirement + Test	Result - Remark	Verdict
	Terminals for the connection of external equipotential bonding conductors allow connection of conductors of 2,5 to 6 mm ² , and		N/A
	do not provide earthing continuity between different parts of the appliance, and		N/A
	conductors cannot be loosened without the aid of a tool		N/A
	Requirements not applicable to class II appliances and class III appliances that incorporate an earth for functional purposes		N/A
27.3	For a detachable part having an earth connection and being plugged into another part of the appliance, the earth connection is made before and separated after current-carrying connections when removing the part		P
	For appliances with supply cords, current-carrying conductors become taut before earthing conductor, if the cord slips out of the cord anchorage		P
	Requirements not applicable to class II appliances and class III appliances that incorporate an earth for functional purposes		N/A
27.4	No risk of corrosion resulting from contact between parts of the earthing terminal and the copper of the earthing conductor or other metal		P
	Parts providing earthing continuity, other than parts of a metal frame or enclosure, have adequate resistance to corrosion		P
	If of steel, these parts provided with an electroplated coating with a thickness at least 5 μm		N/A
	Adequate protection against rusting of parts of coated or uncoated steel, only intended to provide or transmit contact pressure		P
	In the body of the earthing terminal is a part of a frame or enclosure of aluminium or aluminium alloys, precautions taken to avoid risk of corrosion		N/A
	Requirements not applicable to class II appliances and class III appliances that incorporate an earth for functional purposes		N/A
27.5	Low resistance of connection between earthing terminal and earthed metal parts		P

IEC 60335-2-15			
Clause	Requirement + Test	Result - Remark	Verdict
	This requirement does not apply to connections providing earthing continuity in the protective extra-low voltage circuit, provided the clearances of basic insulation are based on the rated voltage of the appliance		N/A
	Requirements not applicable to class II appliances and class III appliances that incorporate an earth for functional purposes		N/A
	Resistance not exceeding 0,1 Ω at the specified low-resistance test (Ω)..... :	Max. 0,046 Ω	P
27.6	The printed conductors of printed circuit boards not used to provide earthing continuity in hand-held appliances		N/A
	They may be used to provide earthing continuity in other appliances if at least two tracks are used with independent soldering points and the appliance complies with 27.5 for each circuit		N/A
	Requirements not applicable to class II appliances and class III appliances that incorporate an earth for functional purposes		N/A
28.1	SCREWS AND CONNECTIONS		--
	Fixings, electrical connections and connections providing earthing continuity withstand mechanical stresses		P
	Screws not of soft metal liable to creep, such as zinc or aluminium		P
	Diameter of screws of insulating material min. 3 mm		N/A
	Screws of insulating material not used for any electrical connections or connections providing earthing continuity		N/A
	Screws used for electrical connections or connections providing earthing continuity screwed into metal		P
	Screws not of insulating material if their replacement by a metal screw can impair supplementary or reinforced insulation		N/A
	For type X attachment, screws to be removed for replacement of supply cord or for user maintenance, not of insulating material if their replacement by a metal screw impairs basic insulation		N/A

IEC 60335-2-15			
Clause	Requirement + Test	Result - Remark	Verdict
	For screws and nuts; torque-test as specified in Table 14..... :	(see appended table)	P
28.2	Electrical connections and connections providing earthing continuity constructed so that contact pressure is not transmitted through non-ceramic insulating material liable to shrink or distort, unless		P
	there is resiliency in the metallic parts to compensate for shrinkage or distortion of the insulating material		N/A
	This requirement does not apply to electrical connections in circuits of appliances for which:		--
	<ul style="list-style-type: none"> 30.2.2 is applicable and that carry a current not exceeding 0,5 A; 		N/A
	<ul style="list-style-type: none"> 30.2.3 is applicable and that carry a current not exceeding 0,2 A 		N/A
28.3	Space-threaded (sheet metal) screws only used for electrical connections if they clamp the parts together		N/A
	Thread-cutting (self-tapping) screws and thread rolling screws only used for electrical connections if they generate a full form standard machine screw thread		N/A
	Thread-cutting (self-tapping) screws not used if they are likely to be operated by the user or installer		N/A
	Thread-cutting, thread rolling and space threaded screws may be used in connections providing earthing continuity provided it is not necessary to disturb the connection:		--
	- in normal use,		N/A
	- during user maintenance,		N/A
	- when replacing a supply cord having a type X attachment, or		N/A
	- during installation		N/A
	At least two screws being used for each connection providing earthing continuity, unless		P
	the screw forms a thread having a length of at least half the diameter of the screw		N/A
28.4	Screws and nuts that make mechanical connection secured against loosening if they also make electrical connections or connections providing earthing continuity		P

IEC 60335-2-15			
Clause	Requirement + Test	Result - Remark	Verdict
	This requirement does not apply to screws in the earthing circuit if at least two screws are used, or		P
	if an alternative earthing circuit is provided		N/A
	Rivets for electrical connections or connections providing earthing continuity secured against loosening if the connections are subjected to torsion		N/A
29	CLEARANCES, CREEPAGE DISTANCES AND SOLID INSULATION		--
	Clearances, creepage distances and solid insulation withstand electrical stress		P
	For coatings used on printed circuits boards to protect the microenvironment (type 1) or to provide basic insulation (type 2), Annex J applies		N/A
	The microenvironment is pollution degree 1 under type 1 protection		N/A
	For type 2 protection, the spacing between the conductors before the protection is applied is not less than the values specified in Table 1 of IEC 60664-3		N/A
	These values apply to functional, basic, supplementary and reinforced insulation		N/A
29.1	Clearances not less than the values specified in Table 16, taking into account the rated impulse voltage for the overvoltage categories of Table 15, unless	(see appended table)	P
	for basic insulation and functional insulation they comply with the impulse voltage test of Clause 14		N/A
	However, if the distances are affected by wear, distortion, movement of the parts or during assembly, the clearances for rated impulse voltages of 1 500 V and above are increased by 0,5 mm and the impulse voltage test is not applicable		P
	For appliances intended for use at altitudes exceeding 2 000 m, the clearances in Table 16 is increased according to the relevant multiplier values in Table A.2 of IEC 60664-1		N/A
	Impulse voltage test is not applicable:		--
	- when the microenvironment is pollution degree 3, or		P
	- for basic insulation of class 0 and class 0I appliances, or		N/A

IEC 60335-2-15			
Clause	Requirement + Test	Result - Remark	Verdict
	- to appliances intended for use at altitudes exceeding 2 000 m		N/A
	Appliances are in overvoltage category II		P
	A force of 2 N is applied to bare conductors, other than heating elements		P
	A force of 30 N is applied to accessible surfaces		P
29.1.1	Clearances of basic insulation withstand the overvoltages, taking into account the rated impulse voltage		P
	The values of Table 16 or the impulse voltage test of Clause 14 are applicable	(see appended table)	P
	Clearance at the terminals of tubular sheathed heating elements may be reduced to 1,0 mm if the microenvironment is pollution degree 1		P
	Lacquered conductors of windings considered to be bare conductors		N/A
29.1.2	Clearances of supplementary insulation not less than those specified for basic insulation in Table 16	(see appended table)	P
29.1.3	Clearances of reinforced insulation not less than those specified for basic insulation in Table 16, using the next higher step for rated impulse voltage	(see appended table)	P
	For double insulation, with no intermediate conductive part between basic and supplementary insulation, clearances are measured between live parts and the accessible surface, and the insulation system is treated as reinforced insulation		P
29.1.4	Clearances for functional insulation are the largest values determined from:		--
	- Table 16 based on the rated impulse voltage :	(see appended table)	P
	- Table F.7a in IEC 60664-1, frequency not exceeding 30 kHz;		N/A
	- Clause 4 of IEC 60664-4, frequency exceeding 30 kHz		N/A
	If values of Table 16 are largest, the impulse voltage test of Clause 14 may be applied instead, unless		N/A
	the microenvironment is pollution degree 3, or		P
	the distances can be affected by wear, distortion, movement of the parts or during assembly		N/A

IEC 60335-2-15			
Clause	Requirement + Test	Result - Remark	Verdict
	However, clearances are not specified if the appliance complies with Clause 19 with the functional insulation short-circuited		N/A
	Lacquered conductors of windings considered to be bare conductors		N/A
	However, clearances at crossover points are not measured		N/A
	Clearance between surfaces of PTC heating elements may be reduced to 1 mm		N/A
29.1.5	Appliances having higher working voltages than rated voltage, clearances for basic insulation are the largest values determined from:		--
	- Table 16 based on the rated impulse voltage :		N/A
	- Table F.7a in IEC 60664-1, frequency not exceeding 30 kHz;		N/A
	- Clause 4 of IEC 60664-4, frequency exceeding 30 kHz		N/A
	If clearances for basic insulation are selected from Table F.7a of IEC 60664-1 or Clause 4 of IEC 60664-4, the clearances of supplementary insulation are not less than those specified for basic insulation		N/A
	If clearances for basic insulation are selected from Table F.7a of IEC 60664-1, the clearances of reinforced insulation dimensioned as specified in Table F.7a are to withstand 160 % of the withstand voltage required for basic insulation		N/A
	If clearances for basic insulation are selected from Clause 4 of IEC 60664-4, the clearances of reinforced insulation are twice the value required for basic insulation		N/A
	If the secondary winding of a step-down transformer is earthed, or if there is an earthed screen between the primary and secondary windings, clearances of basic insulation on the secondary side not less than those specified in Table 16, but using the next lower step for rated impulse voltage		N/A
	Circuits supplied with a voltage lower than rated voltage, clearances of functional insulation are based on the working voltage used as the rated voltage in Table 15		N/A
29.2	Creepage distances not less than those appropriate for the working voltage, taking into account the material group and the pollution degree..... :	(see appended table)	P

IEC 60335-2-15			
Clause	Requirement + Test	Result - Remark	Verdict
	Pollution degree 2 applies, unless		P
	- precautions taken to protect the insulation; pollution degree 1;		P
	- insulation subjected to conductive pollution; pollution degree 3		P
	The microenvironment is pollution degree 3 if the insulation can be polluted by condensation from steam produced during normal use of the appliance (IEC 60335-2-15)		P
	A force of 2 N is applied to bare conductors, other than heating elements		P
	A force of 30 N is applied to accessible surfaces		P
	In a double insulation system, the working voltage for both the basic and supplementary insulation is taken as the working voltage across the complete double insulation system		P
29.2.1	Creepage distances of basic insulation not less than specified in Table 17	(see appended table)	P
	However, if the working voltage is periodic and has a frequency exceeding 30 kHz, the creepage distances are also determined from Table 2 of IEC 60664-4, these values being used if exceeding the values in Table 17		N/A
	Except for pollution degree 1, corresponding creepage distance not less than the minimum specified for the clearance in Table 16, if the clearance has been checked according to the test of Clause 14		N/A
29.2.2	Creepage distances of supplementary insulation at least those specified for basic insulation in Table 17, or	(see appended table)	P
	Table 2 of IEC 60664-4, as applicable		N/A
29.2.3	Creepage distances of reinforced insulation at least double those specified for basic insulation in Table 17, or	(see appended table)	P
	Table 2 of IEC 60664-4, as applicable		N/A
29.2.4	Creepage distances of functional insulation not less than specified in Table 18	(see appended table)	P
	However, if the working voltage is periodic and has a frequency exceeding 30 kHz, the creepage distances are also determined from Table 2 of IEC 60664-4, these values being used if exceeding the values in Table 18		N/A

IEC 60335-2-15			
Clause	Requirement + Test	Result - Remark	Verdict
	Creepage distances may be reduced if the appliance complies with Clause 19 with the functional insulation short-circuited		N/A
29.3	Supplementary and reinforced insulation have adequate thickness, or a sufficient number of layers, to withstand the electrical stresses		P
	Compliance checked:		--
	- by measurement, in accordance with 29.3.1, or		P
	- by an electric strength test in accordance with 29.3.2, or		N/A
	- for insulation, other than single layer internal wiring insulation, by an assessment of the thermal quality of the material combined with an electric strength test, in accordance with 29.3.3, and		N/A
	for accessible parts of reinforced insulation consisting of a single layer, by measurement in accordance with 29.3.4, or		N/A
	- by an assessment of the thermal quality of the material according to 29.3.3 combined with an electric strength test in accordance with 23.5, for each single layer internal wiring insulation touching each other, or		N/A
	- as specified in Subclause 6.3 of IEC 60664-4 for insulation that is subjected to any periodic voltage having a frequency exceeding 30 kHz		N/A
29.3.1	Supplementary insulation have a thickness of at least 1 mm		P
	Reinforced insulation have a thickness of at least 2 mm		P
29.3.2	Each layer of material withstand the electric strength test of 16.3 for supplementary insulation		N/A
	Supplementary insulation consist of at least 2 layers		N/A
	Reinforced insulation consist of at least 3 layers		N/A
29.3.3	The insulation is subjected to the dry heat test Bb of IEC 60068-2-2, followed by		N/A
	the electric strength test of 16.3		N/A
	If the temperature rise during the tests of Clause 19 does not exceed the value specified in Table 3, the test of IEC 60068-2-2 is not carried out		N/A

IEC 60335-2-15			
Clause	Requirement + Test	Result - Remark	Verdict
29.3.4	Thickness of accessible parts of reinforced insulation consisting of a single layer not less than specified in Table 19		N/A
30	RESISTANCE TO HEAT AND FIRE		--
30.1	External parts of non-metallic material,		P
	parts supporting live parts, and		P
	parts of thermoplastic material providing supplementary or reinforced insulation		P
	sufficiently resistant to heat		P
	Ball-pressure test according to IEC 60695-10-2		P
	External parts tested at 40 °C plus the maximum temperature rise determined during the test of Clause 11, or at 75 °C, whichever is the higher; temperature (°C)..... :	(see appended table 30.1)	P
	Parts supporting live parts tested at 40 °C plus the maximum temperature rise determined during the test of Clause 11, or at 125 °C, whichever is the higher; temperature (°C)..... :	(see appended table 30.1)	P
	Parts of thermoplastic material providing supplementary or reinforced insulation tested at 25 °C plus the maximum temperature rise determined during Clause 19, if higher; temperature (°C)	(see appended table 30.1)	P
	For coffee makers, egg boilers, kettles and steam cookers, the temperature rises occurring during the tests of 19.4, 19.5 and 19.101 are not taken into account (IEC 60335-2-15)		P
30.2	Parts of non-metallic material resistant to ignition and spread of fire		P
	This requirement does not apply to:		--
	parts having a mass not exceeding 0,5 g, provided the cumulative effect is unlikely to propagate flames that originate inside the appliance by propagating flames from one part to another, or		P
	decorative trims, knobs and other parts unlikely to be ignited or to propagate flames that originate inside the appliance		P
	Compliance checked by the test of 30.2.1, and in addition:		P
	- for attended appliances, 30.2.2 applies;		P
	- for unattended appliances, 30.2.3 applies		N/A

IEC 60335-2-15			
Clause	Requirement + Test	Result - Remark	Verdict
	For appliances for remote operation, 30.2.3 applies		N/A
	For base material of printed circuit boards, 30.2.4 applies		N/A
	For water distillers, appliances incorporating a delayed start timer and appliances intended to maintain liquid or food at a particular temperature, 30.2.3 applies (IEC 60335-2-15)		N/A
	For other appliances, 30.2.2 applies (IEC 60335-2-15)		P
30.2.1	Parts of non-metallic material subjected to the glow-wire test of IEC 60695-2-11 at 550 °C	(see appended Table 30.2)	P
	However, test not carried out if the material is classified as having a glow-wire flammability index according to IEC 60695-2-12 of at least 550 °C, or		N/A
	the material is classified at least HB40 according to IEC 60695-11-10		N/A
	Parts for which the glow-wire test cannot be carried out need to meet the requirements in ISO 9772 for material classified HBF		N/A
30.2.2	Appliances operated while attended, parts of non-metallic material supporting current-carrying connections, and		P
	parts of non-metallic material within a distance of 3 mm of such connections,		P
	subjected to the glow-wire test of IEC 60695-2-11 with appropriate severity level:		P
	- 750 °C, for connections carrying a current exceeding 0,5 A during normal operation,	(see appended Table 30.2)	P
	- 650 °C, for other connections	(see appended Table 30.2)	P
	Glow-wire applied to an interposed shielding material, if relevant		P
	The glow-wire test is not carried out on parts of material classified as having a glow-wire flammability index according to IEC 60695-2-12 of at least:		--
	- 750 °C, for connections carrying a current exceeding 0,5 A during normal operation,		N/A
	- 650 °C, for other connections		N/A
	The glow-wire test is also not carried out on small parts. These parts are to:		--
	- comprise material having a glow-wire flammability index of at least 750 °C, or 650 °C as appropriate, or		N/A

IEC 60335-2-15			
Clause	Requirement + Test	Result - Remark	Verdict
	- comply with the needle-flame test of Annex E, or		P
	- comprise material classified as V-0 or V-1 according to IEC 60695-11-10		N/A
	Glow-wire test not applicable to conditions as specified		N/A
30.2.3	Appliances operated while unattended, tested as specified in 30.2.3.1 and 30.2.3.2		N/A
	The tests are not applicable to conditions as specified		N/A
30.2.3.1	Parts of non-metallic material supporting connections carrying a current exceeding 0,2 A during normal operation, and		N/A
	parts of non-metallic material, other than small parts, within a distance of 3 mm,		N/A
	subjected to the glow-wire test of IEC 60695-2-11 with a test severity of 850 °C		N/A
	Glow-wire applied to an interposed shielding material, if relevant		N/A
	The glow-wire test is not carried out on parts of material classified as having a glow-wire flammability index according to IEC 60695-2-12 of at least 850 °C		N/A
30.2.3.2	Parts of non-metallic material supporting connections, and		N/A
	parts of non-metallic material within a distance of 3 mm,		N/A
	subjected to the glow-wire test of IEC 60695-2-11 with appropriate severity level:		N/A
	- 750 °C, for connections carrying a current exceeding 0,2 A during normal operation,		N/A
	- 650 °C, for other connections		N/A
	Glow-wire applied to an interposed shielding material, if relevant		N/A
	However, the glow-wire test of 750 °C or 650 °C as appropriate, is not carried out on parts of material fulfilling both or either of the following classifications:		--
	- a glow-wire ignition temperature according to IEC 60695-2-13 of at least:		N/A
	<ul style="list-style-type: none"> • 775 °C, for connections carrying a current exceeding 0,2 A during normal operation, 		N/A
	<ul style="list-style-type: none"> • 675 °C, for other connections 		N/A

IEC 60335-2-15			
Clause	Requirement + Test	Result - Remark	Verdict
	- a glow-wire flammability index according to IEC 60695-2-12 of at least:		N/A
	- 750 °C, for connections carrying a current exceeding 0,2 A during normal operation,		N/A
	- 650 °C, for other connections		N/A
	The glow-wire test is also not carried out on small parts. These parts are to:		--
	- comprise material having a glow-wire ignition temperature of at least 775 °C or 675 °C as appropriate, or		N/A
	- comprise material having a glow-wire flammability index of at least 750 °C or 650 °C as appropriate, or		N/A
	- comply with the needle-flame test of Annex E, or		N/A
	- comprise material classified as V-0 or V-1 according to IEC 60695-11-10		N/A
	The consequential needle-flame test of Annex E applied to non-metallic parts that encroach within the vertical cylinder placed above the centre of the connection zone and on top of the non-metallic parts supporting current-carrying connections, and parts of non-metallic material within a distance of 3 mm of such connections if these parts are those:		--
	- parts that withstood the glow-wire test of IEC 60695-2-11 of 750 °C or 650 °C as appropriate, but produce a flame that persist longer than 2 s, or		N/A
	- parts that comprised material having a glow-wire flammability index of at least 750 °C or 650 °C as appropriate, or		N/A
	- small parts, that comprised material having a glow-wire flammability index of at least 750 °C or 650 °C as appropriate, or		N/A
	- small parts for which the needle-flame test of Annex E was applied, or		N/A
	- small parts for which a material classification of V-0 or V-1 was applied		N/A
	However, the consequential needle-flame test is not carried out on non-metallic parts, including small parts, within the cylinder that are:		--
	- parts having a glow-wire ignition temperature of at least 775 °C or 675 °C as appropriate, or		N/A
	- parts comprising material classified as V-0 or V-1 according to IEC 60695-11-10, or		N/A

IEC 60335-2-15			
Clause	Requirement + Test	Result - Remark	Verdict
	- parts shielded by a flame barrier that meets the needle-flame test of Annex E or that comprises material classified as V-0 or V-1 according to IEC 60695-11-10		N/A
30.2.4	Base material of printed circuit boards subjected to the needle-flame test of Annex E		N/A
	Test not applicable to conditions as specified..... :		N/A
31	RESISTANCE TO RUSTING		--
	Relevant ferrous parts adequately protected against rusting		P
	Tests specified in part 2 when necessary		N/A
32	RADIATION, TOXICITY AND SIMILAR HAZARDS		--
	Appliance does not emit harmful radiation or present a toxic or similar hazard due to their operation in normal use		P
	Compliance is checked by the limits or tests specified in part 2, if relevant		N/A
A	ANNEX A (INFORMATIVE) ROUTINE TESTS		--
	Description of routine tests to be carried out by the manufacturer		N/A
B	ANNEX B (NORMATIVE) APPLIANCES POWERED BY RECHARGEABLE BATTERIES THAT ARE RECHARGED IN THE APPLIANCE		--
	The following modifications to this standard are applicable for appliances powered by batteries that are recharged in the appliance		N/A
	Three forms of construction covered:		--
	a) Appliance supplied directly from the supply mains or a renewable energy source, the battery charging circuitry and other supply unit circuitry incorporated within the appliance		N/A
	b) The part of the appliance incorporating the battery is supplied from the supply mains or a renewable energy source, via a detachable supply unit. The battery charging circuitry is incorporated within the part of the appliance containing the battery		N/A

IEC 60335-2-15			
Clause	Requirement + Test	Result - Remark	Verdict
	c) The part of the appliance incorporating the battery is supplied from the supply mains or a renewable energy source, via a detachable supply unit. The battery charging circuitry is incorporated within the detachable supply unit		N/A
3.1.9	Appliance operated under the following conditions:		--
	- the appliance, supplied by its fully charged battery, operated as specified in relevant part 2;		N/A
	- the battery is charged, the battery being initially discharged to such an extent that the appliance cannot operate;		N/A
	- if possible, the appliance is supplied from the supply mains through its battery charger, the battery being initially discharged to such an extent that the appliance cannot operate. The appliance is operated as specified in relevant part 2;		N/A
	- if the appliance incorporates inductive coupling between two parts that are detachable from each other, the appliance is supplied from the supply mains with the detachable part removed		N/A
3.6.2	Part to be removed in order to discard the battery is not considered to be detachable		N/A
5.B.101	Appliances supplied from the supply mains tested as specified for motor-operated appliances		N/A
7.1	Battery compartment for batteries intended to be replaced by the user, marked with battery voltage (V) and polarity of the terminals :		N/A
	The positive terminal indicated by symbol IEC 60417-5005 and the negative terminal by symbol IEC 60417-5006		N/A
	Appliances intending to be supplied from a detachable supply unit marked with symbol IEC 60417-6181 and its type reference along with symbol ISO 7000-0790 (2004-01), or		N/A
	use only with <model designation> supply unit ... :		N/A
7.6	Additional symbols		N/A
7.12	The instructions give information regarding charging		N/A
	Instructions for appliances incorporating batteries intended to be replaced by the user include required information		N/A
	Details about how to remove batteries containing materials hazardous to the environment given		N/A

IEC 60335-2-15			
Clause	Requirement + Test	Result - Remark	Verdict
	Instructions for appliances containing non-user-replaceable batteries state the substance of the following:		--
	This appliance contains batteries that are only replaceable by skilled persons		N/A
	Instructions for appliances containing non-replaceable batteries shall state the substance of the following:		--
	This appliance contains batteries that are non-replaceable		N/A
	For appliances intending to be supplied from a detachable supply unit for the purposes of recharging the battery, the type reference of the detachable supply unit is stated along with the following:		--
	WARNING: For the purposes of recharging the battery, only use the detachable supply unit provided with this appliance		N/A
	If the symbol for detachable supply unit is used, its meaning is explained		N/A
7.15	Markings placed on the part of the appliance connected to the supply mains		N/A
	The type reference of the detachable supply unit is placed in close proximity to the symbol		N/A
8.2	Appliances having batteries that according to the instruction may be replaced by the user need only have basic insulation between live parts and the inner surface of the battery compartment		N/A
	If the appliance can be operated without batteries, double or reinforced insulation required		N/A
11.7	The battery is charged for the period stated in the instructions or 24 h		N/A
11.8	Temperature rise of the battery surface does not exceed the limit in the battery manufacturer's specification; measured (K); limit (K)		N/A
	If no limit specified, the temperature rise does not exceed 20 K; measured (K)		N/A
19.1	Appliances subjected to tests of 19.B.101, 19.B.102 and 19.B.103		N/A
19.10	Not applicable		N/A
19.B.101	Appliances supplied at rated voltage for 168 h, the battery being continually charged		N/A
19.B.102	For appliances having batteries that can be removed without the aid of a tool, short-circuit of the terminals of the battery, the battery being fully charged		N/A

IEC 60335-2-15			
Clause	Requirement + Test	Result - Remark	Verdict
19.B.103	Appliances having batteries replaceable by the user supplied at rated voltage under normal operation with the battery removed or in any position allowed by the construction		N/A
19.13	The battery does not rupture or ignite		N/A
21.B.101	Appliances having pins for insertion into socket-outlets have adequate mechanical strength		N/A
	Part of the appliance incorporating the pins subjected to the free fall test, procedure 2, of IEC 60068-2-31, the number of falls being:		--
	- 100, if the mass of the part does not exceed 250 g (g)		N/A
	- 50, if the mass of the part exceeds 250 g (g).....		N/A
	After the test, the requirements of 8.1, 15.1.1, 16.3 and Clause 29 are met		N/A
22.3	Appliances having pins for insertion into socket-outlets tested as fully assembled as possible		N/A
25.13	An additional lining or bushing not required for interconnection cords in class III appliances or class III constructions operating at safety extra-low voltage not containing live parts		N/A
30.2	For parts of the appliance connected to the supply mains during the charging period, 30.2.3 applies		N/A
	For other parts, 30.2.2 applies		N/A
C	ANNEX C (NORMATIVE) AGEING TEST ON MOTORS		--
	Tests, as described, carried out when doubt with regard to the temperature classification of the insulation of a motor winding		N/A
	Test conditions as specified		N/A
	The value of p in Table C.1 is 2 000 (IEC 60335-2-15)		N/A
D	ANNEX D (NORMATIVE) THERMAL MOTOR PROTECTORS		--
	Applicable to appliances having motors that incorporate thermal motor protectors necessary for compliance with the standard		N/A
	Test conditions as specified		N/A
E	ANNEX E (NORMATIVE) NEEDLE-FLAME TEST		--
	Needle-flame test carried out in accordance with IEC 60695-11-5, with the following modifications:		--

IEC 60335-2-15			
Clause	Requirement + Test	Result - Remark	Verdict
7	Severities		--
	The duration of application of the test flame is 30 s ± 1 s		P
9	Test procedure		--
9.1	The specimen so arranged that the flame can be applied to a vertical or horizontal edge as shown in the examples of Figure 1		P
9.2	The first paragraph does not apply		P
	If possible, the flame is applied at least 10 mm from a corner		P
9.3	The test is carried out on one specimen		P
	If the specimen does not withstand the test, the test may be repeated on two additional specimens, both withstanding the test		N/A
11	Evaluation of test results		--
	The duration of burning not exceeding 30 s		P
	However, for printed circuit boards, the duration of burning not exceeding 15 s		N/A
F	ANNEX F (NORMATIVE) CAPACITORS		--
	Capacitors likely to be permanently subjected to the supply voltage, and used for radio interference suppression or voltage dividing, comply with the following clauses of IEC 60384-14, with the following modifications:		--
1.5	Terms and definitions		--
1.5.3	Class X capacitors tested according to subclass X2		N/A
1.5.4	This subclause is applicable		N/A
1.6	Marking		--
	Items a) and b) are applicable		N/A
3.4	Approval testing		--
3.4.3.2	Table 3 is applicable as described		N/A
4.1	Visual examination and check of dimensions		--
	This subclause is applicable		N/A
4.2	Electrical tests		--
4.2.1	This subclause is applicable		N/A
4.2.5	This subclause is applicable		N/A
4.2.5.2	Only Table 11 is applicable		N/A
	Values for test A apply		N/A

IEC 60335-2-15			
Clause	Requirement + Test	Result - Remark	Verdict
	However, for capacitors in heating appliances the values for test B or C apply		N/A
4.12	Damp heat, steady state		--
	This subclause is applicable		N/A
	Only insulation resistance and voltage proof are checked		N/A
4.13	Impulse voltage		--
	This subclause is applicable		N/A
4.14	Endurance		--
	Subclauses 4.14.1, 4.14.3, 4.14.4 and 4.14.7 are applicable		N/A
4.14.7	Only insulation resistance and voltage proof are checked		N/A
	No visible damage		N/A
4.17	Passive flammability test		--
	This subclause is applicable		N/A
4.18	Active flammability test		--
	This subclause is applicable		N/A
G	ANNEX G (NORMATIVE) SAFETY ISOLATING TRANSFORMERS		--
	The following modifications to this standard are applicable for safety isolating transformers:		--
7	Marking and instructions		--
7.1	Transformers for specific use marked with:		--
	- name, trademark or identification mark of the manufacturer or responsible vendor..... :		N/A
	- model or type reference		N/A
17	Overload protection of transformers and associated circuits		--
	Fail-safe transformers comply with Subclause 15.5 of IEC 61558-1		N/A
22	Construction		--
	Subclauses 19.1 and 19.1.2 of IEC 61558-2-6 are applicable		N/A
29	Clearances, creepage distances and solid insulation		--
29.1, 29.2, 29.3	The distances specified in items 2a, 2c and 3 in Table 13 of IEC 61558-1 apply		N/A

IEC 60335-2-15			
Clause	Requirement + Test	Result - Remark	Verdict
	For insulated winding wires complying with Subclause 19.12.3 of IEC 61558-1 there are no requirements for clearances or creepage distances		N/A
	For windings providing reinforced insulation, the distance specified in item 2c of Table 13 of IEC 61558-1 is not assessed		N/A
	For safety isolating transformers subjected to periodic voltages with a frequency exceeding 30 kHz, the clearances, creepage distances and solid insulation values specified in IEC 60664-4 are applicable, if greater than the values specified in items 2a, 2c and 3 in Table 13 of IEC 61558-1		N/A
H	ANNEX H (NORMATIVE) SWITCHES		--
	Switches comply with the following clauses of IEC 61058-1, as modified below:		--
	The tests of IEC 61058-1 carried out under the conditions occurring in the appliance		N/A
	Before being tested, switches are operated 20 times without load		N/A
8	Marking and documentation		--
	Switches are not required to be marked		N/A
	However, a switch that can be tested separately from the appliance marked with the manufacturer's name or trade mark and the type reference		N/A
13	Mechanism		--
	The tests may be carried out on a separate sample		N/A
15	Insulation resistance and dielectric strength		--
15.1	Not applicable		N/A
15.2	Not applicable		N/A
15.3	Applicable for full disconnection and micro-disconnection		N/A
17	Endurance		--
	Compliance is checked on three separate appliances or switches		N/A
	For 17.2.4.4, the number of cycles declared according to 7.1.4 is 10 000, unless		N/A
	otherwise specified in 24.1.3 of the relevant part 2 of IEC 60335..... :		N/A
	Switches for operation under no load and which can be operated only by a tool, and		N/A

IEC 60335-2-15			
Clause	Requirement + Test	Result - Remark	Verdict
	switches operated by hand that are interlocked so that they cannot be operated under load,		N/A
	are not subjected to the tests		N/A
	However, switches without this interlock are subjected to the test of 17.2.4.4 for 100 cycles of operation		N/A
	Subclauses 17.2.2 and 17.2.5.2 not applicable		N/A
	The ambient temperature during the test is that occurring in the appliance during the test of Clause 11 in IEC 60335-1		N/A
	The temperature rise of the terminals not more than 30 K above the temperature rise measured in Clause 11 of IEC 60335-1 (K)		N/A
20	Clearances, creepage distances, solid insulation and coatings of rigid printed board assemblies		--
	Clause 20 is applicable to clearances across full disconnection and micro-disconnection		N/A
	It is also applicable to creepage distances for functional insulation, across full disconnection and micro-disconnection, as stated in Table 24		N/A
I	ANNEX I (NORMATIVE) MOTORS HAVING BASIC INSULATION THAT IS INADEQUATE FOR THE RATED VOLTAGE OF THE APPLIANCE		--
	The following modifications to this standard are applicable for motors having basic insulation that is inadequate for the rated voltage of the appliance:		--
8	Protection against access to live parts		--
8.1	Metal parts of the motor are considered to be bare live parts		N/A
11	Heating		--
11.3	The temperature rise of the body of the motor is determined instead of the temperature rise of the windings		N/A
11.8	The temperature rise of the body of the motor, where in contact with insulating material, not exceeding values in Table 3 for the relevant insulating material		N/A
16	Leakage current and electric strength		--
16.3	Insulation between live parts of the motor and its other metal parts is not subjected to the test		N/A
19	Abnormal operation		--
19.1	The tests of 19.7 to 19.9 are not carried out		N/A

IEC 60335-2-15			
Clause	Requirement + Test	Result - Remark	Verdict
19.1.101	Appliance operated at rated voltage with each of the following fault conditions:		--
	- short circuit of the terminals of the motor, including any capacitor incorporated in the motor circuit;		N/A
	- short circuit of each diode of the rectifier;		N/A
	- open circuit of the supply to the motor;		N/A
	- open circuit of any parallel resistor, the motor being in operation		N/A
	Only one fault simulated at a time, the tests carried out consecutively		N/A
22	Construction		--
22.1.101	For class I appliances incorporating a motor supplied by a rectifier circuit, the d.c. circuit being insulated from accessible parts of the appliance by double or reinforced insulation		N/A
	Compliance checked by the tests specified for double and reinforced insulation		N/A
J	ANNEX J (NORMATIVE) COATED PRINTED CIRCUIT BOARDS		--
	Testing of protective coatings of printed circuit boards carried out in accordance with IEC 60664-3 with the following modifications:		--
5.7	Conditioning of the test specimens		--
	When production samples are used, three samples of the printed circuit board are tested		N/A
5.7.1	Cold		--
	The test is carried out at - 25 °C		N/A
5.7.3	Rapid change of temperature		--
	Severity 1 is specified		N/A
5.9	Additional tests		--
	This subclause is not applicable		N/A
K	ANNEX K (NORMATIVE) OVERVOLTAGE CATEGORIES		--
	The information on overvoltage categories is extracted from IEC 60664-1		P
	Overvoltage category is a numeral defining a transient overvoltage condition		P
	Equipment of overvoltage category IV is for use at the origin of the installation		N/A

IEC 60335-2-15			
Clause	Requirement + Test	Result - Remark	Verdict
	Equipment of overvoltage category III is equipment in fixed installations and for cases where the reliability and the availability of the equipment is subject to special requirements		N/A
	Equipment of overvoltage category II is energy consuming equipment to be supplied from the fixed installation		P
	If such equipment is subjected to special requirements with regard to reliability and availability, overvoltage category III applies		N/A
	Equipment of overvoltage category I is equipment for connection to circuits in which measures are taken to limit transient overvoltages to an appropriate low level		N/A
L	ANNEX L (INFORMATIVE) GUIDANCE FOR THE MEASUREMENT OF CLEARANCES AND CREEPAGE DISTANCES		--
	Information for the determination of clearances and creepage distances		P
M	ANNEX M (NORMATIVE) POLLUTION DEGREE		--
	The information on pollution degrees is extracted from IEC 60664-1		P
	Pollution		--
	The microenvironment determines the effect of pollution on the insulation, taking into account the macroenvironment		P
	Means may be provided to reduce pollution at the insulation by effective enclosures or similar		P
	Minimum clearances specified where pollution may be present in the microenvironment		P
	Degrees of pollution in the microenvironment		--
	For evaluating creepage distances, the following degrees of pollution in the microenvironment are established:		--
	- pollution degree 1: no pollution or only dry, non-conductive pollution occurs. The pollution has no influence		P
	- pollution degree 2: only non-conductive pollution occurs, except that occasionally a temporary conductivity caused by condensation is to be expected		P

IEC 60335-2-15			
Clause	Requirement + Test	Result - Remark	Verdict
	- pollution degree 3: conductive pollution occurs or dry non-conductive pollution occurs that becomes conductive due to condensation that is to be expected		P
	- pollution degree 4: the pollution generates persistent conductivity caused by conductive dust or by rain or snow		N/A
N	ANNEX N (NORMATIVE) PROOF TRACKING TEST		--
	The proof tracking test is carried out in accordance with IEC 60112 with the following modifications:		--
7	Test apparatus		--
7.3	Test solutions		--
	Test solution A is used		P
10	Determination of proof tracking index (PTI)		--
10.1	Procedure		--
	The proof voltage is 100 V, 175 V, 400 V or 600 V (V)..... :	175 V	P
	The test is carried out on five specimens		P
	In case of doubt, additional test with proof voltage reduced by 25 V, the number of drops increased to 100		N/A
10.2	Report		--
	The report states if the PTI value was based on a test using 100 drops with a test voltage of (PTI-25) V		N/A
O	ANNEX O (INFORMATIVE) SELECTION AND SEQUENCE OF THE TESTS OF CLAUSE 30		--
	Description of tests for determination of resistance to heat and fire		P
P	ANNEX P (INFORMATIVE) GUIDANCE FOR THE APPLICATION OF THIS STANDARD TO APPLIANCES USED IN TROPICAL CLIMATES		--
	Modifications applicable for class 0 and 0I appliances having a rated voltage exceeding 150 V, intended to be used in countries having a tropical climate and that are marked with symbol IEC 60417-6332 (2015-06)		--
	Modifications may also be applied to class I appliances having a rated voltage exceeding 150 V, intended to be used in countries having a tropical climate and that are marked with symbol IEC 60417-6332 (2015-06), if liable to be connected to a supply mains that excludes the protective earthing conductor		--

IEC 60335-2-15			
Clause	Requirement + Test	Result - Remark	Verdict
5.7	The ambient temperature for the tests of Clauses 11 and 13 is 40 ⁺³ ₀ °C		N/A
7.1	The appliance marked with symbol IEC 60417-6332 (2015-06)		N/A
7.6	[Symbol IEC 60417-6332 (2015-06)] tropical climate, as indicated		N/A
7.12	The instructions state that the appliance is to be supplied through a residual current device (RCD) having a rated residual operating current not exceeding 30 mA		N/A
	The instructions state that the appliance is considered to be suitable for use in countries having a tropical climate, but may also be used in other countries		N/A
	If symbol IEC 60417-6332 (2015-06) is used, its meaning shall be explained		N/A
11.8	The values of Table 3 are reduced by 15 K		N/A
13.2	The leakage current for class I appliances not exceeding 0,5 mA (mA).....:		N/A
15.3	The value of t is 37 °C		N/A
16.2	The leakage current for class I appliances not exceeding 0,5 mA (mA).....:		N/A
19.13	The leakage current test of 16.2 is applied in addition to the electric strength test of 16.3		N/A
Q	ANNEX Q (INFORMATIVE) SEQUENCE OF TESTS FOR THE EVALUATION OF ELECTRONIC CIRCUITS		--
	Description of tests for appliances incorporating electronic circuits		N/A
R	ANNEX R (NORMATIVE) SOFTWARE EVALUATION		--
	Programmable electronic circuits requiring software incorporating measures to control the fault/error conditions specified in Table R.1 or R.2 validated in accordance with the requirements of this annex		N/A
R.1	Programmable electronic circuits using software		--
	Programmable electronic circuits requiring software incorporating measures to control the fault/error conditions specified in Table R.1 or R.2 constructed so that the software does not impair compliance with the requirements of this standard		N/A
R.2	Requirements for the architecture		--

IEC 60335-2-15			
Clause	Requirement + Test	Result - Remark	Verdict
	Programmable electronic circuits requiring software incorporating measures to control the fault/error conditions specified in Table R.1 or R.2 use measures to control and avoid software-related faults/errors in safety-related data and safety-related segments of the software		N/A
R.2.1.1	Programmable electronic circuits requiring software incorporating measures to control the fault/error conditions specified in Table R.2 have one of the following structures:		--
	- single channel with periodic self-test and monitoring;		N/A
	- dual channel (homogenous) with comparison;		N/A
	- dual channel (diverse) with comparison		N/A
	Programmable electronic circuits requiring software incorporating measures to control the fault/error conditions specified in Table R.1 have one of the following structures:		--
	- single channel with functional test;		N/A
	- single channel with periodic self-test;		N/A
	- dual channel without comparison		N/A
R.2.2	Measures to control faults/errors		--
R.2.2.1	When redundant memory with comparison is provided on two areas of the same component, the data in one area is stored in a different format from that in the other area		N/A
R.2.2.2	Programmable electronic circuits with functions requiring software incorporating measures to control the fault/error conditions specified in Table R.2 and that use dual channel structures with comparison, have additional fault/error detection means for any fault/errors not detected by the comparison		N/A
R.2.2.3	For programmable electronic circuits with functions requiring software incorporating measures to control the fault/error conditions specified in Table R.1 or R.2, means are provided for the recognition and control of errors in transmissions to external safety-related data paths		N/A
R.2.2.4	For programmable electronic circuits with functions requiring software incorporating measures to control the fault/error conditions specified in Table R.1 or R.2, the programmable electronic circuits incorporate measures to address the fault/errors in safety-related segments and data indicated in Table R.1 and R.2 as appropriate		N/A

IEC 60335-2-15			
Clause	Requirement + Test	Result - Remark	Verdict
R.2.2.5	For programmable electronic circuits with functions requiring software incorporating measures to control the fault/error conditions specified in Table R.1 or R.2, detection of a fault/error occur before compliance with Clause 19 is impaired		N/A
R.2.2.6	The software is referenced to relevant parts of the operating sequence and the associated hardware functions		N/A
R.2.2.7	Labels used for memory locations are unique		N/A
R.2.2.8	The software is protected from user alteration of safety-related segments and data		N/A
R.2.2.9	Software and safety-related hardware under its control is initialized and terminates before compliance with Clause 19 is impaired		N/A
R.3	Measures to avoid errors		--
R.3.1	General		--
	For programmable electronic circuits with functions requiring software incorporating measures to control the fault/error conditions specified in Table R.1 or R.2, the following measures to avoid systematic fault in the software are applied		--
	Software that incorporates measures used to control the fault/error conditions specified in Table R.2 is inherently acceptable for software required to control the fault/error conditions specified in Table R.1		N/A
R.3.2	Specification		--
R.3.2.1	Software safety requirements:	Software Id:	N/A
	The specification of the software safety requirements includes the descriptions listed		N/A
R.3.2.2	Software architecture		--
R.3.2.2.1	The specification of the software architecture includes the aspects listed <ul style="list-style-type: none"> - techniques and measures to control software faults/errors (refer to R.2.2); - interactions between hardware and software; - partitioning into modules and their allocation to the specified safety functions; - hierarchy and call structure of the modules (control flow); - interrupt handling; - data flow and restrictions on data access; - architecture and storage of data; - time-based dependencies of sequences and data 	Document ref. No:	N/A

IEC 60335-2-15			
Clause	Requirement + Test	Result - Remark	Verdict
R.3.2.2.2	The architecture specification is validated against the specification of the software safety requirements by static analysis		N/A
R.3.2.3	Module design and coding		--
R.3.2.3.1	Based on the architecture design, software is suitably refined into modules		N/A
	Software module design and coding is implemented in a way that is traceable to the software architecture and requirements		N/A
R.3.2.3.2	Software code is structured		N/A
R.3.2.3.3	Coded software is validated against the module specification by static analysis		N/A
	The module specification is validated against the architecture specification by static analysis		N/A
R.3.3.3	Software validation		--
	The software is validated with reference to the requirements of the software safety requirements specification		N/A
	Compliance is checked by simulation of:		--
	- input signals present during normal operation,		N/A
	- anticipated occurrences,		N/A
	- undesired conditions requiring system action		N/A

TABLE R.1 ^e – GENERAL FAULT/ERROR CONDITIONS						N/A
Component ^a	Fault/error	Acceptable measures ^{b, c}	Definitions	Document reference for applied measure	Document reference for applied test	Verdict
1 Central processing unit (CPU)						N/A
1.1 Registers	Stuck at	Functional test, or periodic self-test using either: - static memory test, or - word protection with single bit redundancy	H.2.16.5 H.2.16.6 H.2.19.6 H.2.19.8.2			N/A
1.2 VOID						N/A

IEC 60335-2-15						
Clause	Requirement + Test		Result - Remark			Verdict
1.3 Programme counter	Stuck at	Functional test, or periodic self-test, or independent time-slot monitoring, or logical monitoring of the programme sequence	H.2.16.5 H.2.16.6 H.2.18.10.4 H.2.18.10.2			N/A
2 Interrupt handling and execution	No interrupt or too frequent interrupt	Functional test, or time-slot monitoring	H.2.16.5 H.2.18.10.4			N/A
3 Clock	Wrong frequency (for quartz synchronized clock: harmonics/ sub-harmonics only)	Frequency monitoring, or time slot monitoring	H.2.18.10.1 H.2.18.10.4			N/A
4 Memory						N/A
4.1 Invariable memory	All single bit faults	Periodic modified checksum, or multiple checksum, or word protection with single bit redundancy	H.2.19.3.1 H.2.19.3.2 H.2.19.8.2			N/A
4.2 Variable memory	DC fault	Periodic static memory test, or word protection with single bit redundancy	H.2.19.6 H.2.19.8.2			N/A
4.3 Addressing (relevant to variable and invariable memory)	Stuck at	Word protection with single bit redundancy including the address	H.2.19.8.2			N/A
5 Internal data path	Stuck at	Word protection with single bit redundancy	H.2.19.8.2			N/A
5.1 VOID						N/A
5.2 Addressing	Wrong address	Word protection with single bit redundancy including the address	H.2.19.8.2			N/A

IEC 60335-2-15						
Clause	Requirement + Test		Result - Remark			Verdict
6 External communication	Hamming distance 3	Word protection with multi-bit redundancy, or CRC – single work, or transfer redundancy, or protocol test	H.2.19.8.1 H.2.19.4.1 H.2.18.2.2 H.2.18.14			N/A
6.1 VOID						N/A
6.2 VOID						N/A
6.3 Timing	Wrong point in time Wrong sequence	Time-slot monitoring, or scheduled transmission Time-slot and logical monitoring, or comparison of redundant communication channels by either: - reciprocal comparison - independent hardware comparator Logical monitoring, or time-slot monitoring, or scheduled transmission	H.2.18.10.4 H.2.18.18 H.2.18.10.3 H.2.18.15 H.2.18.3 H.2.18.10.2 H.2.18.10.4 H.2.18.18			N/A
7 Input/output periphery	Fault conditions specified in 19.11.2	Plausibility check	H.2.18.13			N/A
7.1 VOID						N/A
7.2 Analogy I/O						N/A
7.2.1 A/D- and D/A- convertor	Fault conditions specified in 19.11.2	Plausibility check	H.2.18.13			N/A
7.2.2 Analog multiplexer	Wrong addressing	Plausibility check	H.2.18.13			N/A
8 VOID						N/A
9 Custom chips ^d e.g. ASIC, GAL, gate array	Any output outside the static and dynamic functional specification	Periodic self-test	H.2.16.6			N/A

IEC 60335-2-15			
Clause	Requirement + Test	Result - Remark	Verdict

NOTE A Stuck-at fault model denotes a fault model representing an open circuit or a non-varying signal level. A DC fault model denotes a stuck-at fault model incorporating short circuit between signal lines.

- a) For fault/error assessment, some components are divided into their sub-functions.
- b) For each sub-function in the table, the Table R.2 measure will cover the software fault/error.
- c) Where more than one measure is given for a sub-function, these are alternatives.
- d) To be divided as necessary by the manufacturer into sub-functions.
- e) Table R.1 is applied according to the requirements of R.1 to R.2.2.9 inclusive.

S	ANNEX S (NORMATIVE) BATTERY OPERATED APPLIANCES POWERED BY BATTERIES THAT ARE NON-RECHARGEABLE OR NOT RECHARGED IN THE APPLIANCE		--
	The following modifications to this standard are applicable for battery-operated appliances where the batteries are either non-rechargeable (primary batteries), or		N/A
	rechargeable batteries (secondary batteries) that are not recharged in the appliance		N/A
5.8.1	If the supply terminals for the connection of the battery have no indication of polarity, the more unfavourable polarity is applied		N/A
5.S.101	Appliances intended for use with a battery box are tested with the battery box supplied with the appliance or with the battery box recommended in the instructions		N/A
5.S.102	Appliances are tested as motor-operated appliances.		N/A
7.1	Appliances marked with the battery voltage (V) and the polarity of the terminals, unless.....: :		N/A
	the polarity is irrelevant		N/A
	Appliances also marked with:		--
	– name, trade mark or identification mark of the manufacturer or responsible vendor: :		N/A
	– model or type reference: :		N/A
	– IP number according to degree of protection against ingress of water, other than IPX0: :		N/A
	– type reference of battery or batteries: :		N/A
	If relevant, the positive terminal is indicated by the symbol IEC 60417-5005 and the negative terminal by the symbol IEC 60417-5006		N/A
	If appliances use more than one battery, they are marked to indicate correct polarity connection of the batteries		N/A

IEC 60335-2-15			
Clause	Requirement + Test	Result - Remark	Verdict
7.6	Additional symbols		N/A
7.12	The instructions contain the following, as applicable:		--
	– the types of batteries that may be used:		N/A
	– how to remove and insert the batteries;		N/A
	– non-rechargeable batteries are not to be recharged;		N/A
	– rechargeable batteries are to be removed from the appliance before being charged;		N/A
	– different types of batteries or new and used batteries are not to be mixed;		N/A
	– batteries are to be inserted with the correct polarity;		N/A
	– exhausted batteries are to be removed from the appliance and safely disposed of;		N/A
	– if the appliance is to be stored unused for a long period, the batteries are removed;		N/A
	– the supply terminals are not to be short-circuited		N/A
11.5	Appliances are supplied with the most unfavourable supply voltage between		--
	– 0,55 and 1,0 times the battery voltage, if the appliance can be used with non-rechargeable batteries		N/A
	– 0,75 and 1,0 times battery voltage, if the appliance is designed for use with rechargeable batteries only		N/A
	The values specified in Table S.101 for the internal resistance per cell of the battery is taken into account		N/A
19.1	The tests are carried out with the battery fully charged unless otherwise specified		N/A
19.13	The battery does not rupture or ignite		N/A
19.S.101	Appliances are supplied with the voltage specified in 11.5. The supply terminals having an indication of polarity are connected to the opposite polarity, unless		N/A
	such a connection is unlikely to occur due to the construction of the appliance		N/A
19.S.102	For appliances with provision for multiple batteries, one or more of the batteries are reversed and the appliance is operated, if reversal of batteries is allowed by the construction		N/A

IEC 60335-2-15			
Clause	Requirement + Test	Result - Remark	Verdict
25.5	The flexible leads or flexible cord used to connect an external battery or battery box in is connected to the appliance by a type X attachment		N/A
25.13	This requirement is not applicable to the flexible leads or flexible cord connecting external batteries or a battery box with an appliance		N/A
25.S.101	Appliances have suitable means for connection of the battery. If the type of battery is marked on the appliance, the means of connection is suitable for this type of battery		N/A
26.5	Terminal devices in an appliance for the connection of the flexible leads or flexible cord connecting an external battery or battery box are so located or shielded that there is no risk of accidental connection between supply terminals		N/A
30.2.3.2	There is no battery in the area of the vertical cylinder used for the consequential needle flame test, unless		N/A
	the battery is shielded by a barrier that meets the needle flame test of Annex E, or		N/A
	that comprises material classified as V-0 or V-1 according to IEC 60695-11-10		N/A
T	ANNEX T (NORMATIVE) UV-C RADIATION EFFECT ON NON-METALLIC MATERIALS		--
	Requirements for non-metallic materials subject to direct or reflected UV-C radiation exposure and whose mechanical and electrical properties are relied upon for compliance with the		N/A
	Does not apply to glass, ceramic and similar materials		N/A
	Tested as specified in ISO 4892-1 and ISO 4892-2, with the following modifications:		--
	Modifications to ISO 4892-1:		--
5.1	Light source		--
5.1.6	The UV-C emitter is a low pressure mercury lamp with a quartz envelope having a continuous spectral irradiance of 10 W/m ² at 254 nm		N/A
	Subclause 5.1.6.1 and Table 1 are not applicable		N/A
5.2	Temperature		--
5.2.4	The black-panel temperature shall be 63 °C ± 3 °C		N/A
5.3	Humidity and wetting		--

IEC 60335-2-15			
Clause	Requirement + Test	Result - Remark	Verdict
5.3.1	Humidification of the chamber air is specified in part 2 when necessary		N/A
9	Test report		--
	This clause is not applicable		N/A
	Modifications to ISO 4892-2:		--
7	Procedure		--
7.1	General		--
	At least three test specimens are tested		N/A
	Ten samples of internal wiring is tested		N/A
7.2	Mounting the test specimens		--
	The specimens are attached to the specimen holders such that they are not subject to any stress		N/A
7.3	Exposure		--
	Apparatus prepared as specified		N/A
	The test specimens and, if used, the irradiance-measuring instrument are exposed for 1 000 h		N/A
7.4	Measurement of radiant exposure		--
	If used, a radiometer is mounted and calibrated such that it measures the irradiance at the exposed surface of the test specimen		N/A
7.5	Determination of changes in properties after exposure		--
	Material properties and test methods for parts providing mechanical support or impact resistance as specified in Table T.1		N/A
	Material properties and test method for electrical insulation of internal wiring as specified in Table T.2		N/A
8	Exposure report		--
	This clause is not applicable		N/A

10.1	TABLE: Power input deviation					P
Input deviation of/at:	P rated (W)	P measured (W)	ΔP (W, %)	Required ΔP (W, %)	Remark	
230 V, 50Hz	1350	1372,6	+1,7%	+5%, -10%	TPCK0508-13	
230 V, 60Hz	1350	1370,9	+1,5%	+5%, -10%		
230 V, 50Hz	1500	1559,0	+3,9%	+5%, -10%	TPGK1318-15	
230 V, 60Hz	1500	1556,0	+3,7%	+5%, -10%		
230 V, 50Hz	1800	1873,0	+4,1%	+5%, -10%	TPGK1218-18	
230 V, 60Hz	1800	1871,0	+3,9%	+5%, -10%		
230 V, 50Hz	1800	1873,2	+4,1%	+5%, -10%	TPSK0318-18	
230 V, 60Hz	1800	1868,8	+3,8%	+5%, -10%		
230 V, 50Hz	1800	1880,2	+4,5%	+5%, -10%	TPCK0118-18	
230 V, 60Hz	1800	1877,6	+4,3%	+5%, -10%		
230 V, 50Hz	1800	1847,6	+2,6%	+5%, -10%	TPSK7625-18	
230 V, 60Hz	1800	1838,8	+2,2%	+5%, -10%		
Supplementary information: --						

10.2	TABLE: Current deviation					N/A
Current deviation of/at:	I rated (A)	I measured (A)	ΔI (A, %)	Required ΔI (A, %)	Remark	
Supplementary information: --						

11.8-1	TABLE: Heating test (For model TPCK0508-13)			P
	Test voltage (V).....	1,15 x (240/230) ² x1350 W = 1690 W / 255,0V		—
	Ambient (°C).....	22,8 – 22,3 °C		—
Thermocouple locations		Max. temperature rise measured, ΔT (K)	Max. temperature rise limit, ΔT (K)	
Power cord		16,8	50	
Plastic of stand cover inner		13,3	For clause 30.1	
Plastic of stand bottom inner		19,5	For clause 30.1	
Ambient of connector		32,1	T125-25=100	
Pin of inlet		33,0	45	
Plastic of kettle bottom inner		25,2	For clause 30.1	
Plastic of indicator cover inner		36,0	For clause 30.1	
Plastic of handle inner		66,0	For clause 30.1	

Ambient of thermal control system	46,2	T125-25=100
Thermal cut-out left	38,8	Ref.
Thermal cut-out right	42,6	Ref.
Temperature limiter	30,7	T125-25=100
Internal wire to heating element	71,0	T200 -25=175
Internal wire to indicator	41,4	T200 -25=175
Tube of indicator internal wire	56,7	T125-25=100
Handle of kettle	29,4	60
Projection of kettle	37,8	60
Grip of lid	50,7	60
Temperature limiter button	23,2	60
Test floor	10,2	65
11.z101 external surface		
Plastic of stand top surface	21,4	65
Plastic of stand side surface	5,9	65
Plastic of connector surface	24,8	65
Plastic of kettle bottom around surface	29,5	65
Plastic of handle around surface	52,4	65
Plastic kettle enclosure	51,3	65
Supplementary information: test with thermal control TIANMING.		

11.8-2	TABLE: Heating test (For model TPGK1318-15)		P
	Test voltage (V)	1,15 x (240/230) ² x1500 W = 1878,3 W / 253,2V	—
	Ambient (°C)	22,6 – 23,3 °C	—
Thermocouple locations		Max. temperature rise measured, ΔT (K)	Max. temperature rise limit, ΔT (K)
Power cord		17,5	50
Plastic of stand cover inner		13,7	For clause 30.1
Plastic of stand bottom inner		11,9	For clause 30.1
Ambient of connector		42,5	T125-25=100
Pin of inlet		27,4	45
Plastic of kettle bottom inner		25,6	For clause 30.1
Plastic of indicator cover inner		61,1	For clause 30.1
Plastic of handle inner		63,5	For clause 30.1
Ambient of thermal control system		35,5	T125-25=100
Thermal cut-out left		65,2	Ref.

Thermal cut-out right	66,0	Ref.
Temperature limiter	63,3	T125-25=100
Internal wire to heating element	54,6	T200 -25=175
Internal wire to indicator	35,0	T200 -25=175
Tube of indicator internal wire	45,0	T125-25=100
Handle of kettle	9,5	60
Projection of kettle	34,1	60
Grip of lid	42,9	60
Temperature limiter button	14,1	60
Test floor	10,6	65
11.z101 external surface		
Plastic of stand top surface	17,3	65
Plastic of stand side surface	5,6	65
Plastic of connector surface	33,7	65
Plastic of kettle bottom around surface	20,1	65
Plastic of handle around surface	46,8	65
Plastic kettle enclosure	35,5	65
Supplementary information: tested with thermal control ZUANBAO.		

11.8-3	TABLE: Heating test (For model TPGK1218-18)		P
	Test voltage (V)	1,15 x (240/230) ² x1800 W = 2254 W / 252,3V	—
	Ambient (°C)	22,9 – 23,6 °C	—
Thermocouple locations		Max. temperature rise measured, ΔT (K)	Max. temperature rise limit, ΔT (K)
Power cord		19,4	50
Plastic of stand cover inner		13,0	For clause 30.1
Plastic of stand bottom inner		12,1	For clause 30.1
Ambient of connector		45,7	T125-25=100
Pin of inlet		15,8	45
Plastic of kettle bottom inner		27,9	For clause 30.1
Plastic of indicator cover inner		52,7	For clause 30.1
Plastic of handle inner		55,7	For clause 30.1
Ambient of thermal control system		52,1	T125-25=100
Thermal cut-out left		51,8	Ref.
Thermal cut-out right		45,3	Ref.
Temperature limiter		51,6	T125-25=100

Internal wire to heating element	45,1	T200 -25=175
Internal wire to indicator	33,0	T200 -25=175
Tube of indicator internal wire	48,7	T125-25=100
Handle of kettle	9,0	60
Projection of kettle	33,7	60
Grip of lid	43,8	60
Temperature limiter button	8,9	60
Test floor	9,6	65
11.z101 external surface		
Plastic of stand top surface	3,7	65
Plastic of stand side surface	5,5	65
Plastic of connector surface	26,6	65
Plastic of kettle bottom around surface	22,4	65
Plastic of handle around surface	44,5	65
Plastic kettle enclosure	24,0	65
Supplementary information: Test with thermal control FADA.		

11.8-4	TABLE: Heating test (For model TPSK0318-18)		P
	Test voltage (V)	1,15 x (240/230) ² x1800 W = 2254 W / 252,8V	—
	Ambient (°C)	23,2 – 22,3 °C	—
Thermocouple locations		Max. temperature rise measured, ΔT (K)	Max. temperature rise limit, ΔT (K)
Power cord		23,5	50
Plastic of stand cover inner		20,6	For clause 30.1
Plastic of stand bottom inner		9,6	For clause 30.1
Ambient of connector		37,5	T125-25=100
Pin of inlet		34,9	45
Plastic of kettle bottom inner		29,4	For clause 30.1
Plastic of indicator cover inner		41,0	For clause 30.1
Plastic of handle inner		68,3	For clause 30.1
Ambient of thermal control system		53,4	T125-25=100
Thermal cut-out left		56,6	Ref.
Thermal cut-out right		55,7	Ref.
Temperature limiter		76,1	T125-25=100
Internal wire to heating element		51,8	T200 -25=175
Internal wire to indicator		34,3	T200 -25=175

Tube of indicator internal wire	64,4	T125-25=100
Handle of kettle	14,9	60
Projection of kettle	29,3	60
Grip of lid	46,5	60
Temperature limiter button	16,1	60
Test floor	4,2	65
11.z101 external surface		
Plastic of stand top surface	17,5	65
Plastic of stand side surface	2,8	65
Plastic of connector surface	38,5	65
Plastic of kettle bottom around surface	25,0	65
Plastic of handle around surface	40,3	65
Plastic kettle enclosure	22,9	65
Supplementary information: tested with thermal control ZUANBAO.		

11.8-5	TABLE: Heating test (For model TPSK7625-18)		P
	Test voltage (V)	1,15 x (240/230) ² x1800 W = 2254 W / 253,0V	—
	Ambient (°C)	22,9 – 22,6°C	—
Thermocouple locations		Max. temperature rise measured, ΔT (K)	Max. temperature rise limit, ΔT (K)
Power cord		17,6	50
Plastic of stand cover inner		21,9	For clause 30.1
Plastic of stand bottom inner		17,8	For clause 30.1
Ambient of connector		34,5	T125-25=100
Pin of inlet		36,5	45
Plastic of kettle bottom inner		39,7	For clause 30.1
Plastic of indicator cover inner		26,5	For clause 30.1
Plastic of handle inner		65,0	For clause 30.1
Ambient of thermal control system		37,7	T125-25=100
Thermal cut-out left		43,4	Ref.
Thermal cut-out right		53,6	Ref.
Temperature limiter		50,0	T85-25=60
Internal wire to heating element		50,6	T200 -25=175
Internal wire to indicator		42,0	T200 -25=175
Tube of indicator internal wire		41,2	T125-25=100
Handle of kettle		8,7	60

Projection of kettle	31,7	60
Grip of lid	27,8	60
Temperature limiter button	8,5	60
Test floor	8,9	65
11.z101 external surface		
Plastic of stand top surface	23,5	65
Plastic of stand side surface	7,9	65
Plastic of connector surface	28,3	65
Plastic of kettle bottom around surface	23,0	65
Plastic of handle around surface	42,0	65
Plastic kettle enclosure	26,7	65
Supplementary information: tested with thermal control FUFAN.		

11.8-6	TABLE: Heating test (For model TPCK0118-18)		P
	Test voltage (V)	1,15 x (240/230) ² x1800 W = 2254 W / 251,0V	—
	Ambient (°C)	23,6 – 22,5°C	—
Thermocouple locations		Max. temperature rise measured, ΔT (K)	Max. temperature rise limit, ΔT (K)
Power cord		15,9	50
Plastic of stand cover inner		24,8	For clause 30.1
Plastic of stand bottom inner		11,2	For clause 30.1
Ambient of connector		36,0	T125-25=100
Pin of inlet		33,9	45
Plastic of kettle bottom inner		17,1	For clause 30.1
Plastic of indicator cover inner		25,0	For clause 30.1
Plastic of handle inner		47,9	For clause 30.1
Ambient of thermal control system		64,0	T125-25=100
Thermal cut-out left		53,9	Ref.
Thermal cut-out right		35,5	Ref.
Temperature limiter		58,4	T125-25=100
Internal wire to heating element		45,1	T200 -25=175
Internal wire to indicator		43,0	T200 -25=175
Tube of indicator internal wire		34,5	T125-25=100
Handle of kettle		8,2	60
Projection of kettle		29,1	60
Grip of lid		18,7	60

Temperature limiter button	8,0	60
Test floor	8,3	65
11.z101 external surface		
Plastic of stand top surface	22,4	65
Plastic of stand side surface	6,8	65
Plastic of connector surface	33,3	65
Plastic of kettle bottom around surface	17,8	65
Plastic of handle around surface	33,0	65
Plastic kettle enclosure	52,7	65
Supplementary information: tested with thermal control TIANMING.		

11.8	TABLE: Heating test, resistance method					N/A
	Test voltage (V).....:	--			---	
	Ambient, t₁ (°C).....:	--			---	
	Ambient, t₂ (°C).....:	--			---	
Temperature rise of winding	R1 (Ω)	R2 (Ω)	ΔT (K)	Max. ΔT (K)	Insulation class	
--	--	--	--	--	--	
Supplementary information: --						

13.2	TABLE: Leakage current		P
	Heating appliances: 1,15 x rated input (W).....:	$1,15 \times (240/230)^2 \times 1350 \text{ W} = 1690 \text{ W}$ $1,15 \times (240/230)^2 \times 1500 \text{ W} = 1878,3 \text{ W}$ $1,15 \times (240/230)^2 \times 1800 \text{ W} = 2254 \text{ W}$	---
	Motor-operated and combined appliances: 1,06 x rated voltage (V).....:	--	---
Leakage current between:		I (mA)	Max. allowed I (mA)
Live part and plastic enclosure / switch knob		0,033	0,35 peak
Live part and earthing part		0,068	0,75
Supplementary information: --			

13.3	TABLE: Electric strength			P
Test voltage applied between:		Voltage (V)	Breakdown (Yes/No)	
Live parts and earthing metal		1000	No	
Internal wire and accessible part		1750	No	
Live parts and accessible part		3000	No	
Supplementary information: --				

14	TABLE: Transient overvoltages					N/A
Clearance between:	cl (mm)	Required cl (mm)	Rated impulse voltage (V)	Impulse test voltage (V)	Flashover (Yes/No)	
--	--	--	--	--	--	
Supplementary information: --						

16.2	TABLE: Leakage current			P
Single phase appliances: 1,06 x rated voltage (V)..... :		1,06 x 240 V = 254,4 V		—
Three phase appliances 1,06 x rated voltage divided by $\sqrt{3}$ (V)..... :		--		—
Leakage current between:			I (mA)	Max. allowed I (mA)
Live part and plastic enclosure / switch knob			0,043	0,25
Live part and earthing part			0,088	0,75
Supplementary information: --				

16.3	TABLE: Electric strength			P
Test voltage applied between:		Voltage (V)	Breakdown (Yes/No)	
Live parts and earthing metal		1250	No	
Internal wire and accessible part		1750	No	
Live parts and accessible part		3000	No	
Supplementary information: --				

17	TABLE: Overload protection, thermocouple measurements			N/A
Temperature rise of part/at:		ΔT (K)	Max. ΔT (K)	
--		--	--	

Supplementary information: --

17	TABLE: Overload protection, resistance method					N/A
	Test voltage (V).....:		--		—	
	Ambient, t ₁ (°C).....:		--		—	
	Ambient, t ₂ (°C).....:		--		—	
	Temperature of winding	R1 (Ω)	R2 (Ω)	ΔT (K)	T (°C)	Max. T (°C)
	--	--	--	--	--	--

Supplementary information: --

19	Abnormal operation conditions						P
Operational characteristics			YES/NO	Operational conditions			
Are there electronic circuits to control the appliance operation?			No	--			
Are there “OFF” or “stand-by” position?			Yes	--			
The unintended operation of the appliance results in dangerous malfunction?			No	--			
Subclause	Operating conditions description	Test results description	PEC description	EMP 19.11.4	Software type required	19.11.3 PEC	Final result
19.2	N/A	N/A	N/A	N/A	N/A	N/A	N/A
19.3	1,15 times rated input power container empty or with 10 mm water	No hazard	N/A	N/A	N/A	N/A	P
19.4	1,15 times rated input power, temperature limiter disabled	Thermal cut-out operated	N/A	N/A	N/A	N/A	P
19.5	1,15 times rated input power, temperature limiter disabled	Thermal cut-out operated	N/A	N/A	N/A	N/A	P
19.6	N/A	N/A	N/A	N/A	N/A	N/A	N/A
19.7	N/A	N/A	N/A	N/A	N/A	N/A	N/A
19.8	N/A	N/A	N/A	N/A	N/A	N/A	N/A
19.9	N/A	N/A	N/A	N/A	N/A	N/A	N/A
19.10	N/A	N/A	N/A	N/A	N/A	N/A	N/A
19.11.2	N/A	N/A	N/A	N/A	N/A	N/A	N/A
19.11.3	N/A	N/A	N/A	N/A	N/A	N/A	N/A

19.11.4.8	N/A	N/A	N/A	N/A	N/A	N/A	N/A
19.101	1,15 times rated input power	Thermal cut-out operated	N/A	N/A	N/A	N/A	P
19.102	1,15 times rated input power	Thermal cut-out operated, 100 cycles	N/A	N/A	N/A	N/A	P
Supplementary information: --							

19.7	TABLE: Abnormal operation, locked rotor/moving parts					N/A
	Test voltage (V).....:		--		—	
	Ambient, t ₁ (°C).....:		--		—	
	Ambient, t ₂ (°C).....:		--		—	
	Temperature of winding	R1 (Ω)	R2 (Ω)	ΔT (K)	T (°C)	Max. T (°C)
	--	--	--	--	--	--
Supplementary information: --						

19.9	TABLE: Abnormal operation, running overload					N/A
	Test voltage (V).....:		--		—	
	Ambient, t ₁ (°C).....:		--		—	
	Ambient, t ₂ (°C).....:		--		—	
	Temperature of winding	R1 (Ω)	R2 (Ω)	ΔT (K)	T (°C)	Max. T (°C)
	--	--	--	--	--	--
Supplementary information: --						

19.13-1	TABLE: Abnormal operation, temperature rises (For model TPGK1218-18)				P	
Thermocouple locations		Max. temperature rise measured, ΔT (K)			Max. temperature rise limit, ΔT (K)	
		19.3 a	19.3 b	19.4		19.102
Power cord		40,2	20,4	57,9	37,3	150
Test floor		15,7	3,8	14,7	13,2	150
Test wall		31,4	34,6	46,8	3,4	150
Plastic of stand cover inner		26,2	12,4	--	54,2	For clause 30.1
Plastic of stand bottom inner		25,6	8,2	--	25,1	For clause 30.1
Plastic of kettle bottom inner		64,2	48,0	--	84,8	For clause 30.1
Plastic of indicator cover inner		81,0	57,5	--	70,8	For clause 30.1
Plastic of handle inner		18,5	49,8	--	40,5	For clause 30.1
Thermal cut-out left		96,7	86,1	79,6	187,2	Ref.

Thermal cut-out right	102,6	86,1	115,6	158,4	Ref.
Temperature limiter	6,1	6,1	75,7	6,4	Ref.
Supplementary information: tested with thermal control FADA.					

19.13-2	TABLE: Abnormal operation, temperature rises (For model TPSK0318-18)				P
Thermocouple locations	Max. temperature rise measured, ΔT (K)				Max. temperature rise limit, ΔT (K)
	19.3 a	19.3 b	19.4	19.102	
Power cord	33,9	31,1	61,7	14,8	150
Test floor	25,6	21,8	24,6	5,7	150
Test wall	11,3	5,6	1,2	0,9	150
Plastic of stand cover inner	44,2	41,0	--	12,7	For clause 30.1
Plastic of stand bottom inner	30,3	26,4	--	5,5	For clause 30.1
Plastic of kettle bottom inner	77,9	80,7	--	67,5	For clause 30.1
Plastic of indicator cover inner	61,2	65,7	--	44,7	For clause 30.1
Plastic of handle inner	27,3	62,9	--	25,8	For clause 30.1
Thermal cut-out left	89,9	88,3	128,2	80,6	Ref.
Thermal cut-out right	100,2	99,2	130,6	94,7	Ref.
Temperature limiter	9,5	11,8	26,1	9,6	Ref.
Supplementary information: tested with thermal control ZUANBAO					

19.13-3	TABLE: Abnormal operation, temperature rises (For model TPCK0118-18)				P
Thermocouple locations	Max. temperature rise measured, ΔT (K)				Max. temperature rise limit, ΔT (K)
	19.3 a	19.3 b	19.4	19.102	
Power cord	38,2	41,0	62,0	19,0	150
Test floor	18,5	20,9	26,6	9,3	150
Test wall	26,5	37,6	9,9	0,2	150
Plastic of stand cover inner	42,2	39,5	--	13,4	For clause 30.1
Plastic of stand bottom inner	34,1	37,1	--	25,4	For clause 30.1
Plastic of kettle bottom inner	54,0	56,3	--	39,7	For clause 30.1
Plastic of indicator cover inner	45,0	45,6	--	29,7	For clause 30.1
Plastic of handle inner	3,1	5,4	--	20,7	For clause 30.1
Thermal cut-out left	110,8	111,9	124,9	105,0	Ref.
Thermal cut-out right	100,9	95,4	123,0	118,9	Ref.
Temperature limiter	17,1	59,8	55,6	5,1	Ref.

Supplementary information: tested with thermal control TIANMING

19.13-4	TABLE: Abnormal operation, temperature rises (For model TPSK7625-18)				P
Thermocouple locations	Max. temperature rise measured, ΔT (K)				Max. temperature rise limit, ΔT (K)
	19.3 a	19.3 b	19.4	19.102	
Power cord	21,1	22,6	36,7	19,8	150
Test floor	17,1	18,9	21,6	14,8	150
Test wall	3,7	7,3	0,2	6,3	150
Plastic of stand cover inner	25,8	27,4	--	18,1	For clause 30.1
Plastic of stand bottom inner	19,1	21,5	--	28,9	For clause 30.1
Plastic of kettle bottom inner	29,2	46,6	--	56,1	For clause 30.1
Plastic of indicator cover inner	29,1	38,3	--	34,1	For clause 30.1
Plastic of handle inner	3,3	2,2	--	40,1	For clause 30.1
Thermal cut-out left	68,8	80,1	94,8	83,2	Ref.
Thermal cut-out right	77,3	93,2	104,4	107,7	Ref.
Temperature limiter	5,4	17,5	24,9	94,9	Ref.

Supplementary information: tested with thermal control FUFAN

21.1	TABLE: Impact resistance			P
Impacts per surface	Surface tested	Impact energy (Nm)	Comments	
Three blows	Stand bottom, stand cover	0,5	P	
Three blows	Kettle bottom	0,5	P	
Three blows	Handle	0,5	P	
Three blows	Connector	0,5	P	
Three blows	Kettle body metal / glass	0,5	P	

Supplementary information: --

24.1	TABLE: Components information					P
Object/part No.	Manufacturer/trademark	Type/model	Technical data	Standard	Mark(s) of conformity ¹⁾	
VDE Plug	Guangdong Yincheng Electric Appliance Co. Ltd.	YC-F16	AC250V, 16A	DIN VDE 0620-1 IEC 60884-1	VDE 40026066	

Alternative	Guangdong KaiHua Electric Appliance Co., Ltd	KH-9902	AC250V, 16A	DIN VDE 0620-1 IEC 60884-1	VDE 40010410
Alternative	Ching Cheng Wire Material Co., Ltd.	EL-211	AC250V, 16A	DIN VDE 0620-1 IEC 60884-1	VDE 40000947
BS Plug	Guangdong Yincheng Electric Appliance Co. Ltd.	YC-185	AC 250, 13A (With approved 10A or 13 A fuse link)	BS 1363-1 IEC 60884-1	Dekra 35-105517
Alternative	Guangdong KaiHua Electric Appliance Co., Ltd	KH-9933, KH-9933A	AC 250, 13A (With approved 10A or 13 A fuse link)	BS 1363-1 IEC 60884-1	ASTA NO.1053
Alternative	Ching Cheng Wire Material Co., Ltd.	EL-210, EL-210A	AC 250, 13A (With approved 10A or 13 A fuse link)	BS 1363-1 IEC 60884-1	BSI KM 39096
Malaysia plug	Guangdong Yincheng Electric Appliance Co. Ltd.	YC-185	AC 250, 13A (With approved 10A or 13 A fuse link)	BS 1363-1 MS589-1	SJT161109141 182018
Singapore plug	Guangdong Yincheng Electric Appliance Co. Ltd.	YC-185	AC 250, 13A (With approved 10A or 13 A fuse link)	BS 1363-1 SS 145	181075-11
Brazil Plug	Guangdong Yincheng Electric Appliance Co. Ltd.	YCB-10; YCB-10B	AC 250V, 10A	ABNT NBR NM 60884-1 NBR 14136	TUV 18.1967
South Africa Plug	Guangdong Kaihua Electric Appliance Company Ltd	KH-9907	AC 250V, 16A	SANS 60799	SANS 8688/13707
Australia plug	Guangdong Yincheng Electric Appliance Co. Ltd.	YC-18	AC250V, 10A	AS/NZS 3112	SAA-191016- EA
Supply cord	Guangdong Yincheng Electric Appliance Co. Ltd.	H05VV-F or H03VV-F	3G 0,75mm ² (Length<2m) or 3G 1,0mm ²	EN 50525-2-11 IEC 60227-5	VDE 40018525

Alternative	Guangdong KaiHua Electric Appliance Co., Ltd	H05VV-F or H03VV-F	3G 0,75mm ² (Length<2m) or 3G 1,0mm ²	EN 50525-2-11 IEC 60227-5	VDE 40001903
Alternative	Ching Cheng Wire Material Co., Ltd.	H05VV-F or H03VV-F	3G 0,75mm ² (Length<2m) or 3G 1,0mm ²	EN 50525-2-11 IEC 60227-5	VDE 131809
Alternative	Guangdong Yincheng Electric Appliance Co. Ltd.	H05VV-F or H03VV-F	3G 0,75mm ² (Length<2m) or 3G 1,0mm ²	AS/NZS 60227.5	SAA-190444-EA
Connector 1	Yueqing City Fada Electric Appliance Co., Ltd.	SL-168-2	AC 220-250V, 10A, For very hot condition, 10000 cycles	IEC 60320-1 IEC 60320-2-4	TUV SUD B 17 05 58452 061
Temperature limiter 1	Yueqing City Fada Electric Appliance Co., Ltd.	SL-888	AC 220-250V, 10A, T125, 10000cycles	IEC 60730-1 IEC 60730-2-9	TUV SUD B 13 04 58452 048
Thermal control 1	Yueqing City Fada Electric Appliance Co., Ltd.	SL-168-1	AC 250V, 10A, For very hot condition, Thermal cut-out 3000 cycles	IEC 60730-1 IEC 60730-2-9	TUV SUD B 17 05 58452 063
Connector 2	ZUANBAO ELECTRONIC CO., LTD	KSD185-Z	AC 250V, 10A, T125	IEC 60320-1 IEC 60320-2-4	CQC CB CN35287
Temperature limiter 2	ZUANBAO ELECTRONIC CO., LTD	KSD588-A	AC 250V, 13A, T125, 10000cycles	IEC 60730-1 IEC 60730-2-9	CQC CB CN34958
Thermal control 2	ZUANBAO ELECTRONIC CO., LTD	KSD686-C11	AC 250V, 10A, T125, 10000cycles	IEC 60730-1 IEC 60730-2-9	CQC CB CN35165
Connector 3	Taizhou Tianming Electric Appliance Co., Ltd.	TM-XA-2	AC 100-240V, 13A, For hot conditions, 10000 cycles	IEC 60320-1 IEC 60320-2-4	TUV SUD B 16 05 55675 038
Temperature limiter 3	Taizhou Tianming Electric Appliance Co., Ltd.	TM-XE-3	AC 100-240V, 13A, T125, 10000 cycles	IEC 60730-1 IEC 60730-2-9	TUV SUD B 16 05 55675 036
Thermal control 3	Taizhou Tianming Electric Appliance Co., Ltd.	TM-XG-1	AC 100-240V, 13A, T125, Thermal cut-out 3000 cycles	IEC 60730-1 IEC 60730-2-9	TUV SUD B 16 05 55675 036

Connector 4	YUEQING FUFAN ELECTRIC APPLIANCE CO., LTD.	188B	AC 250 V, 10A, T125	IEC 60320-1 IEC 60320-2-4	CQC CB CN38558
Temperature limiter 4	YUEQING FUFAN ELECTRIC APPLIANCE CO., LTD.	JB-01E	AC 250 V, 10A, T85, 10000 cycles.	IEC 60730-1 IEC 60730-2-9	CQC CB CN38533
Thermal control 4	YUEQING FUFAN ELECTRIC APPLIANCE CO., LTD.	588	AC 250 V, 10A, T125, 10000 cycles.	IEC 60730-1 IEC 60730-2-9	CQC CB CN38534
Internal wire	CIXI SHUANGHONG WIRE CO LTD	3122	200 °C, 300 V, 16-24 AWG	IEC 60335-1 IEC 60335-2-15	Tested with appliance UL E333296
Alternative	CIXI SHUANGHONG WIRE CO., LTD.	H05S-K, H05SJ-K	180 °C, 0,75 mm ² or 1,0 mm ²	IEC 60335-1 IEC 60335-2-15	Tested with appliance VDE 40017324
Alternative	JIANGSU NAIAN SPECIAL CABLE & WIRE CO LTD	3122	200 °C, 300 V, 16-24 AWG	IEC 60335-1 IEC 60335-2-15	Tested with appliance UL E217633
Alternative	FOSHAN SHUNDE PANTAI SPECIAL WIRE ROD ELECTRONICS CO LTD	3122	200 °C, 300 V, 16-24 AWG	IEC 60335-1 IEC 60335-2-15	Tested with appliance UL E346532
Alternative	ZHUHAI HENGWANG ELECTRONICS CO LTD	3122	200 °C, 300 V, 16-24 AWG	IEC 60335-1 IEC 60335-2-15	Tested with appliance UL E314186
Alternative	SHENZHEN MYSUN INSULATION MATERIALS CO LTD	3122	200 °C, 300 V, 16-24 AWG	IEC 60335-1 IEC 60335-2-15	Tested with appliance UL E239689
Alternative	ZHONGSHAN SEN TE WIRE & CABLE CO LTD	3122	200 °C, 300 V, 16-24 AWG	IEC 60335-1 IEC 60335-2-15	Tested with appliance UL E315793
Alternative	POWER ACT ENTERPRISES LTD	3122	200 °C, 300 V, 16-24 AWG	IEC 60335-1 IEC 60335-2-15	Tested with appliance UL E310829

Alternative	JIANGYIN YUANDA ELECTRICAL MATERIAL CO LTD	3122	200 °C, 300 V, 16-24 AWG	IEC 60335-1 IEC 60335-2-15	Tested with appliance UL E216252
Alternative	KELIN WIRE CO LTD (DONGGUAN)	3122	200 °C, 300 V, 16-24 AWG	IEC 60335-1 IEC 60335-2-15	Tested with appliance UL E250866
Alternative	GUANGZHOU FENGTAI MEIHUA CABLE CO LTD	3122	200 °C, 300 V, 16-24 AWG	IEC 60335-1 IEC 60335-2-15	Tested with appliance UL E204798
Alternative	ZHONGSHAN CITY DINGXIANG ELECTRICAL CO LTD	3122	200 °C, 300 V, 16-24 AWG	IEC 60335-1 IEC 60335-2-15	Tested with appliance UL E354487
Alternative	JIANGYIN CITY TIANCHENG ELECTRONIC & CABLE CO LTD	3122	200 °C, 300 V, 16-24 AWG	IEC 60335-1 IEC 60335-2-15	Tested with appliance UL E332921
Alternative	DONG GUAN SHENG PAI ELECTRIC WIRE & CABLE CO LTD	3122	200 °C, 300 V, 16-24 AWG	IEC 60335-1 IEC 60335-2-15	Tested with appliance UL E347603
Alternative	WUXI HUACHENG CABLE CO LTD	3122	200 °C, 300 V, 16-24 AWG	IEC 60335-1 IEC 60335-2-15	Tested with appliance UL E206992
Alternative	CIXI SHUANGHONG WIRE CO LTD	1332	200 °C, 300 V, 16-26 AWG	IEC 60335-1 IEC 60335-2-15	Tested with appliance UL E333296
Alternative	HONG SHUN WIRE & CABLE FLUOROPLAST ICS FACTORY	Style 1332	200 °C, 300 V, 16-26 AWG	IEC 60335-1 IEC 60335-2-15	Tested with appliance UL E238396
Alternative	ZHONGSHAN YIXIN ELECTRICAL CO LTD	Style 1332	200 °C, 300 V, 16-26 AWG	IEC 60335-1 IEC 60335-2-15	Tested with appliance UL E351034
Alternative	QIFURUI ELECTRONICS CO	Style 1332	200 °C, 300 V, 16-26 AWG	IEC 60335-1 IEC 60335-2-15	Tested with appliance UL E211048
Alternative	KELIN WIRE CO LTD (DONGGUAN)	Style 1332	200 °C, 300 V, 16-26 AWG	IEC 60335-1 IEC 60335-2-15	Tested with appliance UL E250866

Alternative	JIANGYIN YUANDA ELECTRICAL MATERIAL CO LTD	Style 1332	200 °C, 300 V, 16-26 AWG	IEC 60335-1 IEC 60335-2-15	Tested with appliance UL E216252
Alternative	ZHUHAI HENGWANG ELECTRONICS CO LTD	Style 1332	200 °C, 300 V, 16-26 AWG	IEC 60335-1 IEC 60335-2-15	Tested with appliance UL E314186
Alternative	GUANGZHOU FENGTAI MEIHUA CABLE CO LTD	Style 1332	200 °C, 300 V, 16-26 AWG	IEC 60335-1 IEC 60335-2-15	Tested with appliance UL E204798
Alternative	FOSHAN CITY ZHENG GUAN FLUORPLASTI CS WIRE FACTORY	Style 1332	200 °C, 300 V, 16-26 AWG	IEC 60335-1 IEC 60335-2-15	Tested with appliance UL E307535
Heating element for model TPGK1318-18, TPGK1218-18, TPGK2218-18, TPSK0315-18, TPSK0515-18, TPSK0318-18, TPSK0518-18, TPSK5218SS- 18, TPSK7318- 18, TPSK7425- 18, TPSK7625- 18, TPSK8518- 18, TPCK0118- 18, TPCK0225- 18, TPCK0318- 18, TPCK0418- 18, TPSK8815- 18	Lianjiang Xiandai Shenghuo Electric Appliance Co., Ltd.	--	AC 220-240V, 1800W	IEC 60335-1 IEC 60335-2-15	Tested with appliance

Heating element for model TPGK1318-15, TPGK1218-15, TPGK2218-15, TPSK0315-15, TPSK0515-15, TPSK0318-15, TPSK0518-15, TPSK5218SS-15, TPSK7318-15, TPSK7425-15, TPSK7625-15, TPSK8518-15, TPSK8815-15	Lianjiang Xiandai Shenghuo Electric Appliance Co., Ltd.	--	AC 220-240V, 1500W	IEC 60335-1 IEC 60335-2-15	Tested with appliance
Heating element for model TPCK0508-13	Lianjiang Xiandai Shenghuo Electric Appliance Co., Ltd.	--	AC 220-240V, 1350W	IEC 60335-1 IEC 60335-2-15	Tested with appliance
Heat shrinkable tubing	Dongguan Salipt Co Ltd	SALIPT S-901-600	125°C, 600 V, VW-1	IEC 60335-1 IEC 60335-2-15	Tested with appliance
Alternative	Guangzhou Kaiheng Enterprise Group	K-2	125 °C, 600 V, VW-1	IEC 60335-1 IEC 60335-2-15	Tested with appliance UL E214175
Alternative	Shenzhen Woer Heat-shrinkable Material Co Ltd	RSFR-H	125 °C, 600 V, VW-1	IEC 60335-1 IEC 60335-2-15	Tested with appliance UL E203950
Alternative	Dong Guan Huang Feng Insulation Material Co Ltd	HFT-2, HFT-01	125°C, 600 V, VW-1	IEC 60335-1 IEC 60335-2-15	Tested with appliance UL E236485
Alternative	Guangzhou Kaiheng New Material Co Ltd	K-102	125 °C, 600 V, VW-1	IEC 60335-1 IEC 60335-2-15	Tested with appliance UL E321827
Alternative	Shenzhen Wolida Trading Co Ltd	RSFR-H	125 °C, 600 V, VW-1	IEC 60335-1 IEC 60335-2-15	Tested with appliance UL E329530
Enclosure/Bottom Cover/handle/baffle of Handle	Maoming Shi Fengxin Trading Co., Ltd.	PP	Min. thickness 1,0 mm	IEC 60335-1 IEC 60335-2-15	Tested with appliance
<p>Supplementary information:</p> <p>1) Provided evidence ensures the agreed level of compliance. See OD-CB2039.</p> <p>2) License available upon request for all the certified components.</p>					

28.1	TABLE: Threaded part torque test			P
Threaded part identification	Diameter of thread (mm)	Column number (I, II, or III)	Applied torque (Nm)	
Earthing nuts	2,70	II	0,4	
Supplementary information: --				

29.1 - 29.2	TABLE: Clearance and creepage distance measurements					P
Clearance cl and creepage distance dcr at/of:	Up (V)	U r.m.s. (V)	Required cl (mm)	cl (mm)	Required dcr (mm)	dcr (mm)
Between live part and earthed metal	--	220V	2,0	4,1	4,0	4,1
Between internal wire and accessible plastic part	--	220V	2,0	4,8	4,0	4,8
Between live part and accessible part of enclosure	--	220V	3,5	8,3	8,0	8,3
Between different L/N polarity of power cord	--	220V	2,0	5,0	3,2	5,0
Supplementary information: --						

29.3	TABLE: Distance through insulation measurements				P
Distance through insulation di at/of:	U r.m.s. (V)	Test voltage (V)	Required di (mm)	di (mm)	
Plastic enclosure	220	--	1,0	1,8	
Indicator cover	220	--	1,0	1,2	
Supplementary information: --					

30.1	TABLE: Ball pressure test of thermoplastics			P
Allowed impression diameter (mm)			≤ 2,0 mm	—
Object/part No./material	Manufacturer/trademark	Test temperature (°C)	Impression diameter (mm)	
Plastic of stand cover	See table 24.1	80	1,1	
Plastic of stand bottom	See table 24.1	75	1,1	
Plastic of kettle bottom	See table 24.1	110	1,8	
Plastic of indicator cover	See table 24.1	106	1,6	
Plastic of handle	See table 24.1	109	1,6	
Supplementary information: --				

30.2	TABLE: Resistance to heat and fire – Glow-wire tests			P
Object/part No./material	Manufacturer/trademark	Glow-wire test (GWT) (°C)	Verdict	

		550	650		750		850	
			ti	te	ti	te		
Plastic of stand cover	See table 24.1	X	--		--		--	P
Plastic of stand bottom	See table 24.1	X	--		--		--	P
Plastic of kettle bottom	See table 24.1	X	--		--		--	P
Plastic of indicator cover	See table 24.1	X	--		--		--	P
Plastic of handle	See table 24.1	X	--		--		--	P
Heat shrinkable tube	See table 24.1	--	--		0 s		--	P
Indicator tube	See table 24.1	--	0 s		--		--	P
Connector	See table 24.1	--	--		0 s		--	P
Thermal control system	See table 24.1	--	--		0 s		--	P
Temperature limiter	See table 24.1	--	--		0 s		--	P
Object/part No./material	Manufacturer/trademark	Glow-wire flammability index (GWFI) (°C)				GW ignition temp. (GWIT) (°C)		Verdict
		550	650	750	850	675	775	
--	--	--	--	--	--	--	--	--
The test specimen passed the glow-wire test (GWT) with no ignition [(te – ti) ≤ 2 s] (Yes/No)... :								Yes
If no, then surrounding parts passed the needle-flame test of Annex E (Yes/No)								N/A
The test specimen passed the test by virtue of most of the flaming material being withdrawn with the glow-wire (Yes/No)?.....								No
Ignition of the specified layer placed underneath the test specimen (Yes/No).....								No
Supplementary information:								
550 °C GWT not relevant (or applicable) to parts of material classified at least HB40 or if relevant HBF. The GWIT pre-selection option, the 850 °C GWFI pre-selection option, and the 850 °C GWT are not relevant (or applicable) for attended appliances.								

30.2/30.2.4 TABLE: Needle-flame test (NFT)					P
Object/part No./material	Manufacturer/trademark	Duration of application of test flame (ta) (s)	Ignition of specified layer Yes/No	Duration of burning (tb) (s)	Verdict
Heat shrinkable tube	See table 24.1	30	No	0	P
Indicator tube	See table 24.1	30	No	0	P
Supplementary information:					
NFT not relevant (or applicable) for parts of material classified as V-0 or V-1.					
NFT not relevant (or applicable) for base material of PCBs classified as V-0 or if relevant VTM-0.					

Overall view, TPGK1218-15, TPGK1218-18 front:



Overall view, TPGK1218-15, TPGK1218-18 right:



Overall view, TPGK1218-15, TPGK1218-18 rear:



Overall view, TPGK1218-15, TPGK1218-18 left:



Overall view, TPGK1218-15, TPGK1218-18 top:



Overall view, TPGK1218-15, TPGK1218-18 kettle bottom:

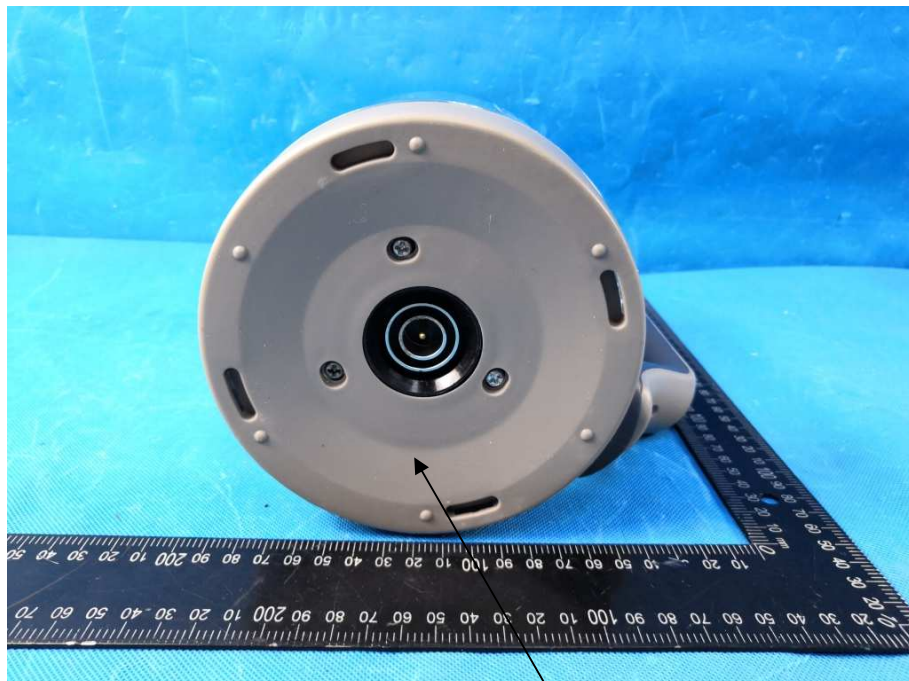

Kettle label location

Overall view, TPGK1218-15, TPGK1218-18 stand bottom:



Stand label location

View of temperature limiter button, TPGK1218-15, TPGK1218-18



Photo Documents

View of water level mark, TPGK1218-15, TPGK1218-18

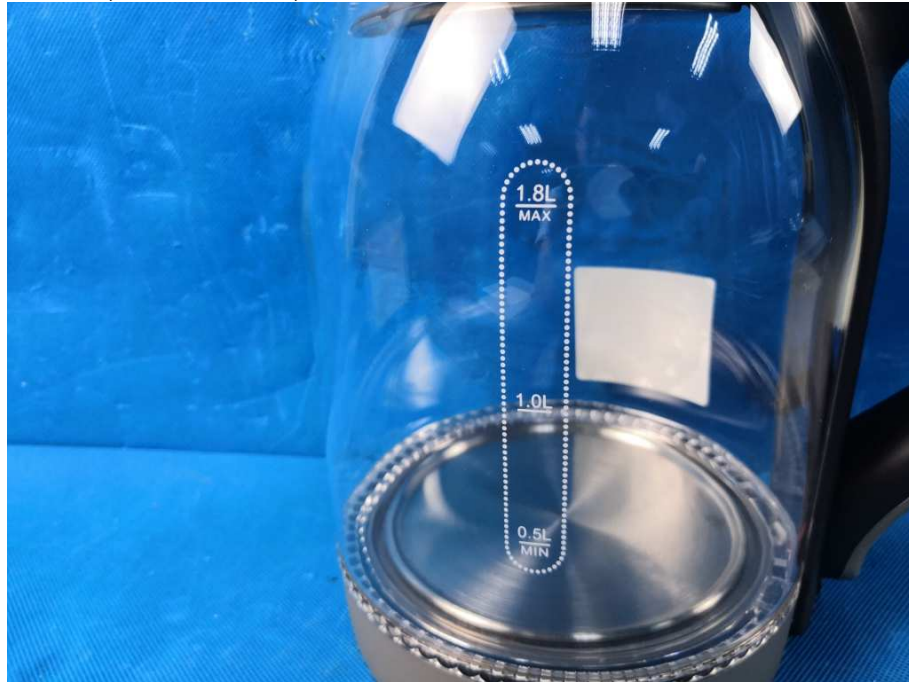

Internal view of stand, TPGK1218-15, TPGK1218-18



View of connector (FADA)

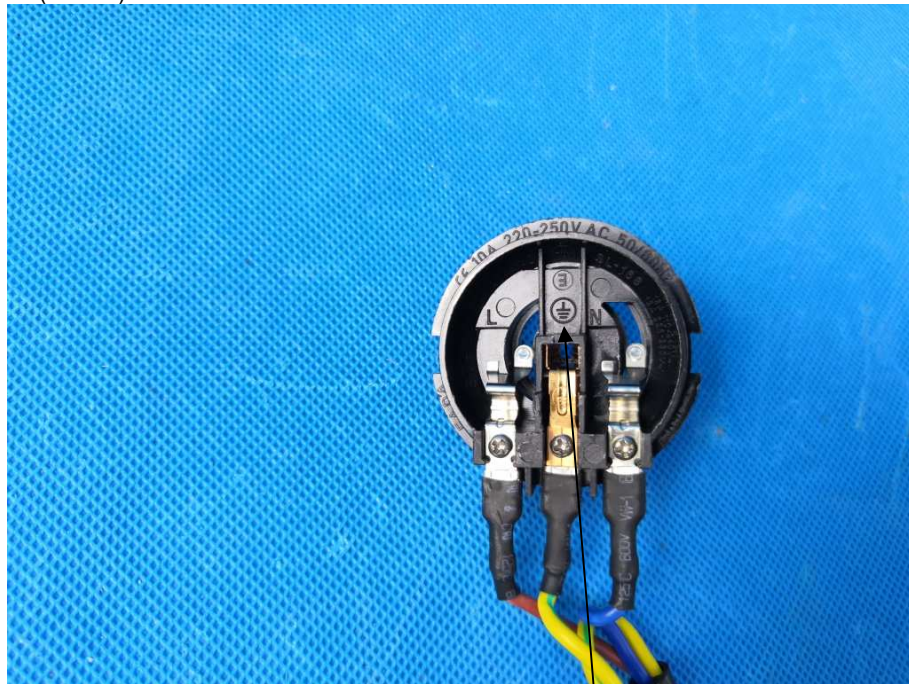

Earthing symbol on terminal

Internal view of kettle, TPGK1218-15, TPGK1218-18



Internal view, TPGK1218-15, TPGK1218-18:



View of thermal control (FADA)

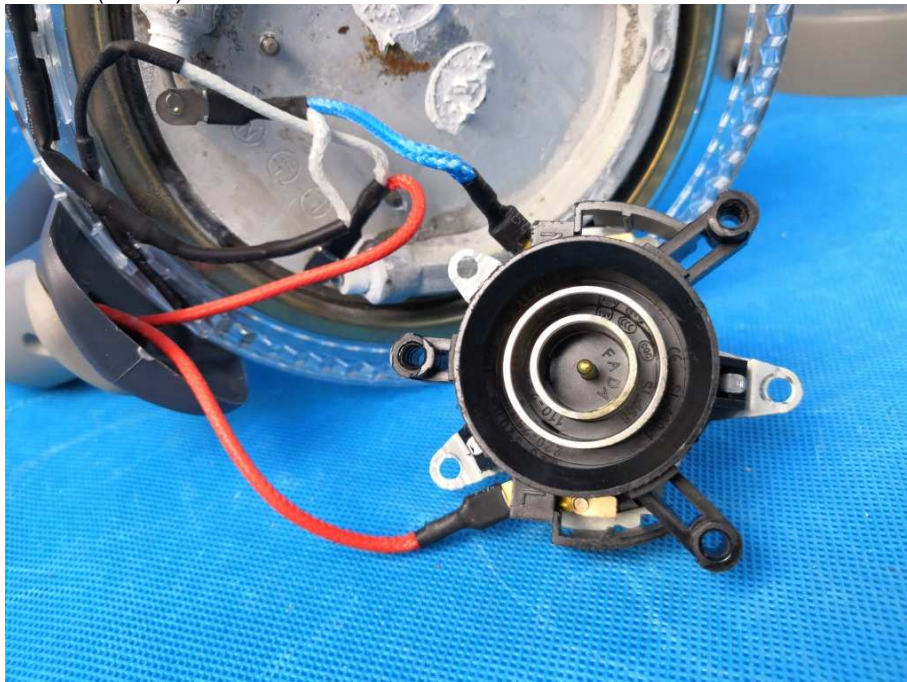

View of thermal control (FADA)

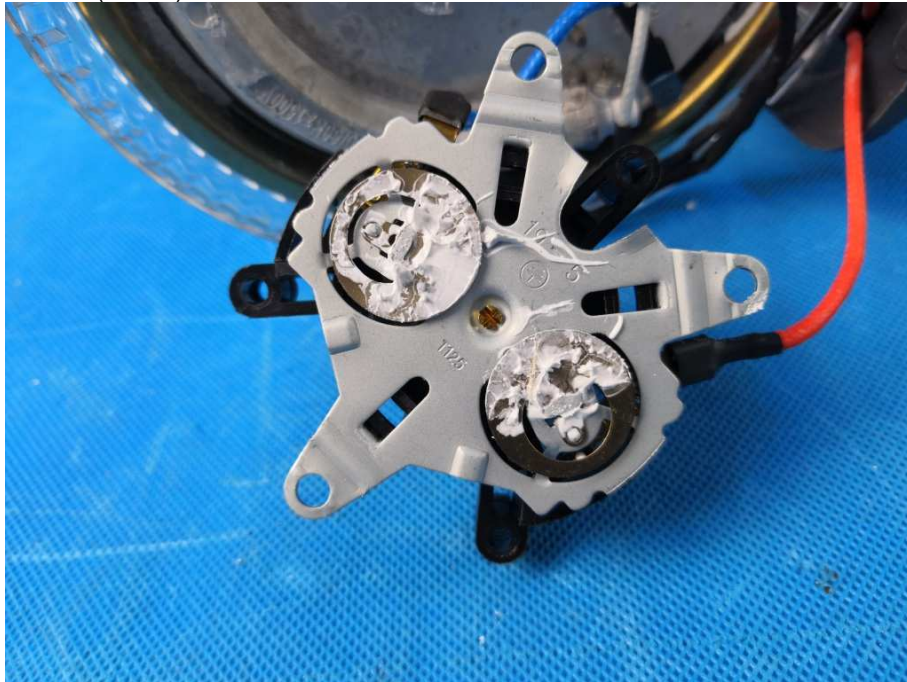

View of indicators

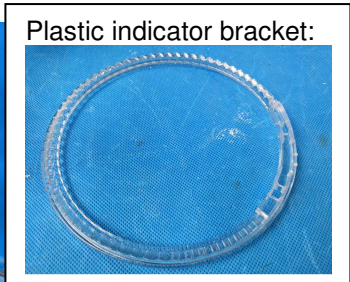
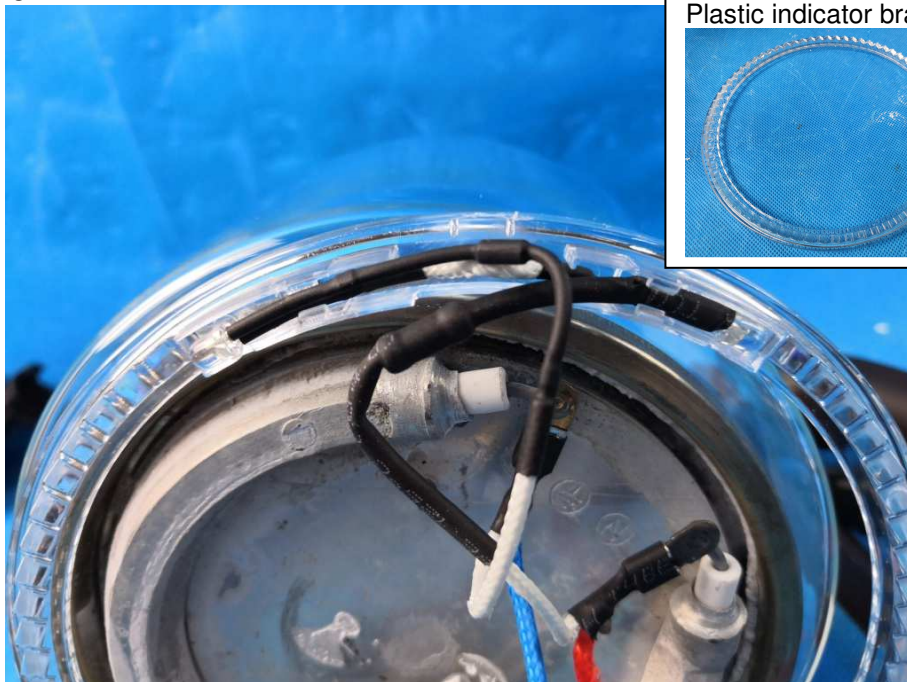

View of heating element, rated 1500 W



View of heating element, rated 1800 W



Photo Documents

Internal view of handle, TPGK1218-15, TPGK1218-18:



View of temperature limiter (FADA)



Overall view, TPGK1318-15, TPGK1318-18, front:



Overall view, TPGK1318-15, TPGK1318-18, right:



Photo Documents

Overall view, TPGK1318-15, TPGK1318-18, rear:



Overall view, TPGK1318-15, TPGK1318-18, left:



Overall view, TPGK1318-15, TPGK1318-18, top:



Overall view, TPGK1318-15, TPGK1318-18, kettle bottom:



Overall view, TPGK1318-15, TPGK1318-18, stand bottom:

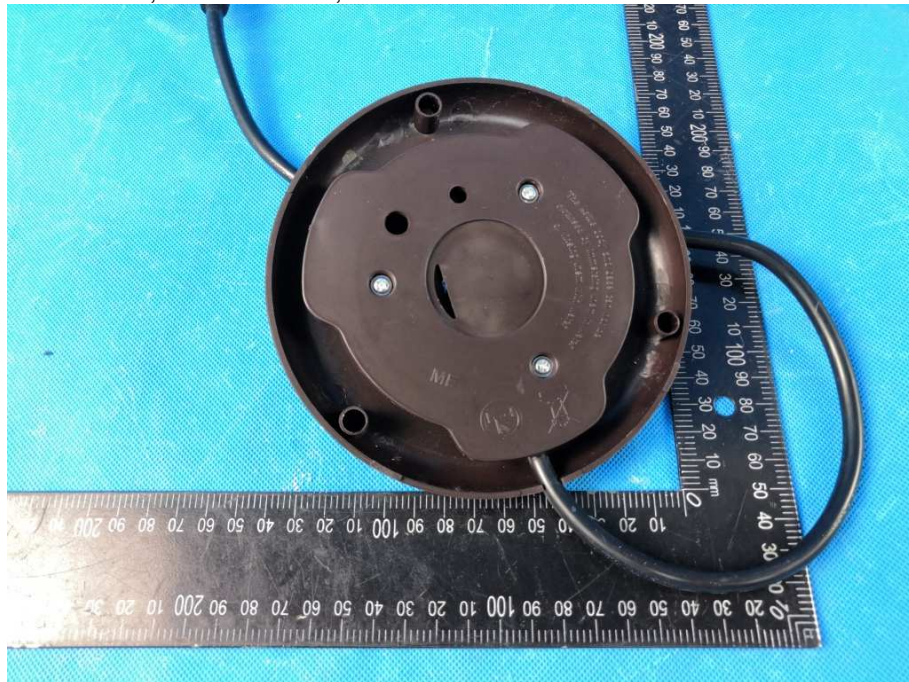

Internal view of stand, TPGK1318-15, TPGK1318-18



View of connector (ZUANBAO)



View of earthing symbol on terminal

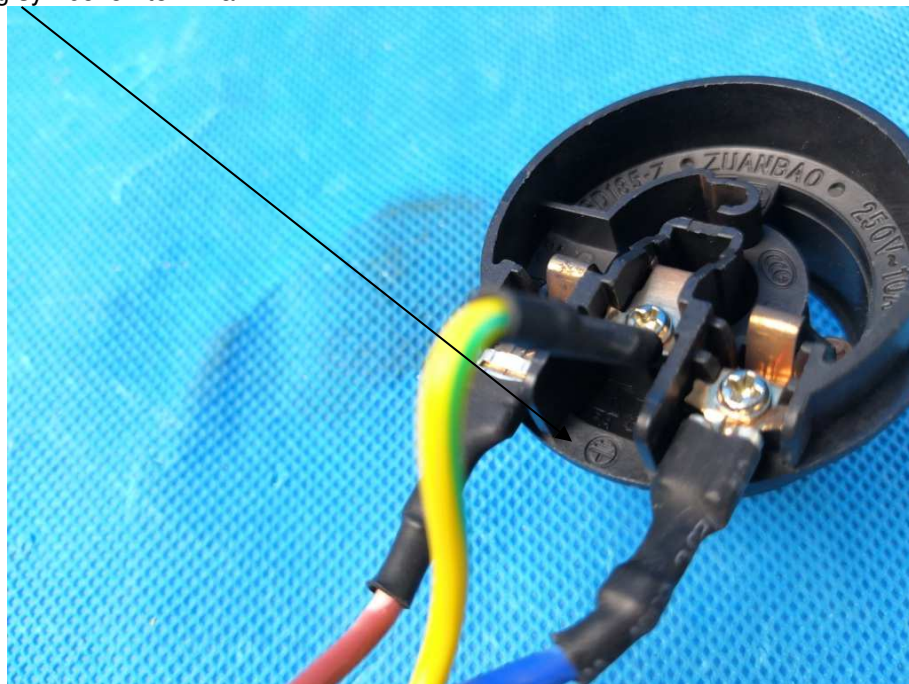

Internal view of kettle, TPGK1318-15, TPGK1318-18



Internal view of kettle, TPGK1318-15, TPGK1318-18



View of thermal control (ZUANBAO)



View of thermal control (ZUANBAO)

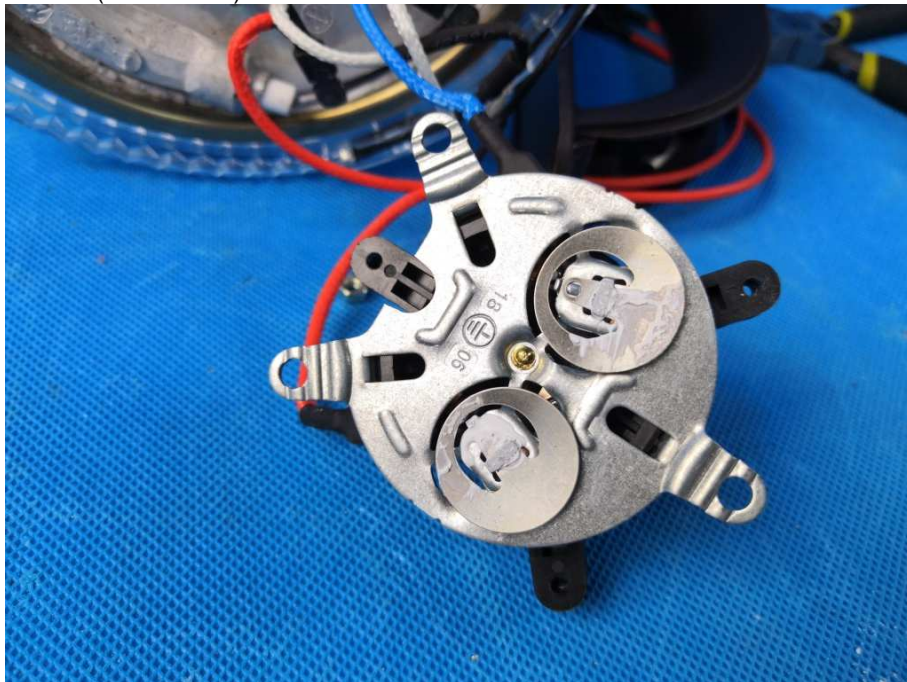

Photo Documents

Internal view of handle, TPGK1318-15, TPGK1318-18



View of temperature limiter (ZUANBAO)



Overall view, TPGK2218-15, TPGK2218-18, front



Overall view, TPGK2218-15, TPGK2218-18, right



Overall view, TPGK2218-15, TPGK2218-18, rear

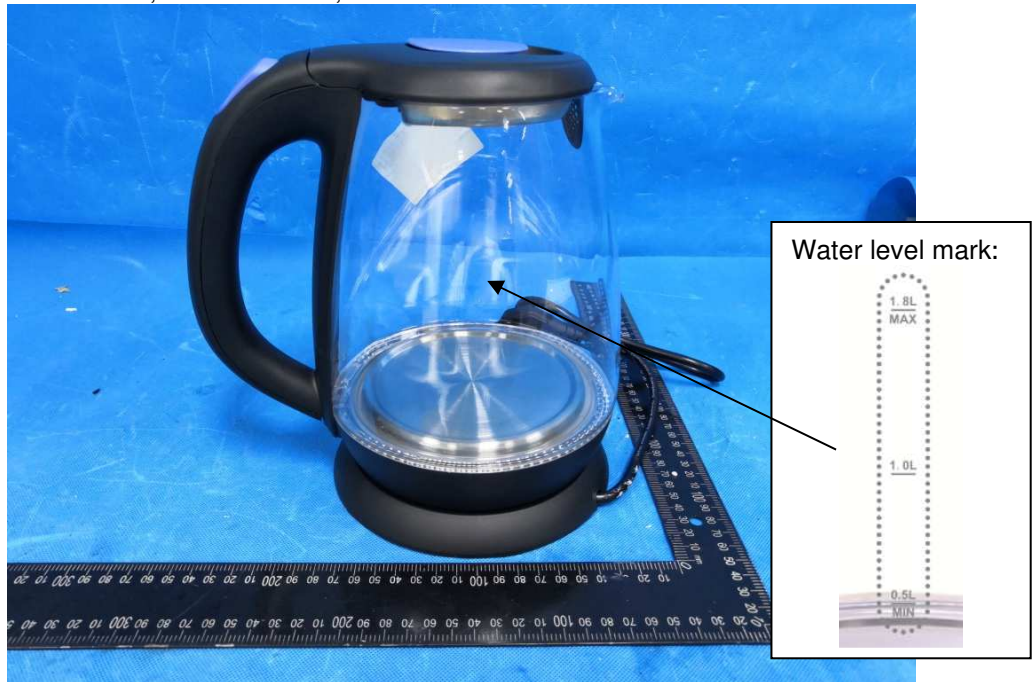

Overall view, TPGK2218-15, TPGK2218-18, left



Overall view, TPGK2218-15, TPGK2218-18, top



Overall view, TPGK2218-15, TPGK2218-18, kettle bottom

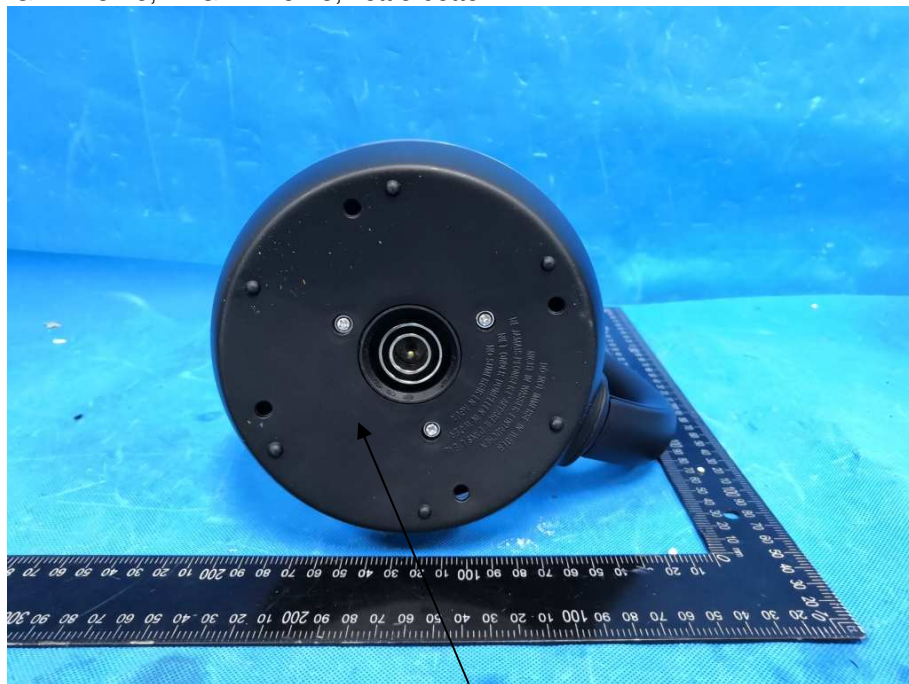

Label location

Photo Documents

Overall view, TPGK2218-15, TPGK2218-18, stand bottom

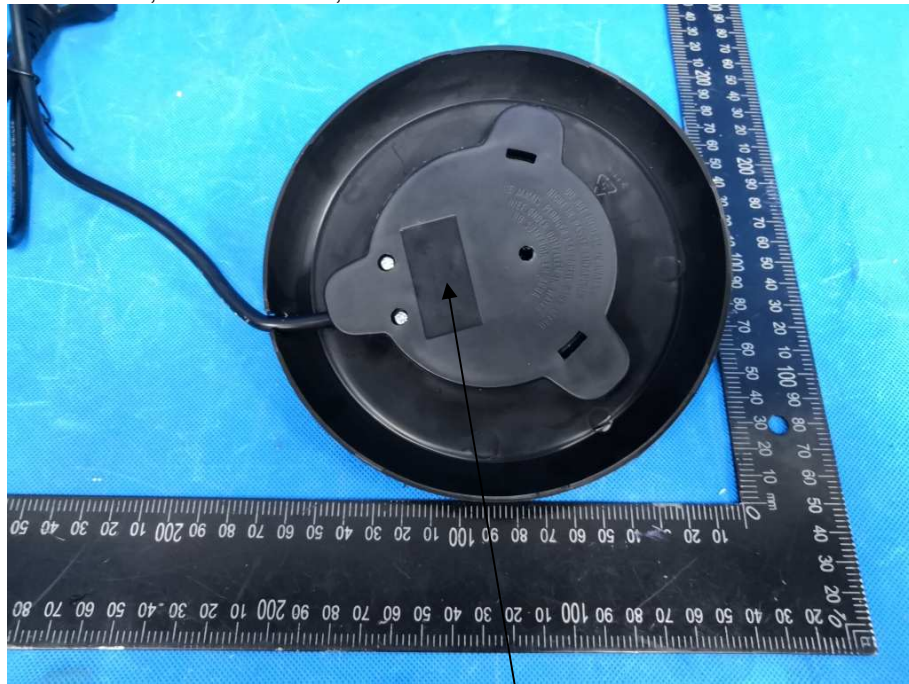

Label location

Internal view of stand, TPGK2218-15, TPGK2218-18



Photo Documents

Internal view of kettle, TPGK2218-15, TPGK2218-18



Internal view of handle, TPGK2218-15, TPGK2218-18



Overall view, TPSK0318-15, TPSK0318-18, front



Overall view, TPSK0318-15, TPSK0318-18, right



Overall view, TPSK0318-15, TPSK0318-18, rear



Overall view, TPSK0318-15, TPSK0318-18, left



Overall view, TPSK0318-15, TPSK0318-18, top



Overall view, TPSK0318-15, TPSK0318-18, kettle bottom



Overall view, TPSK0318-15, TPSK0318-18, stand bottom

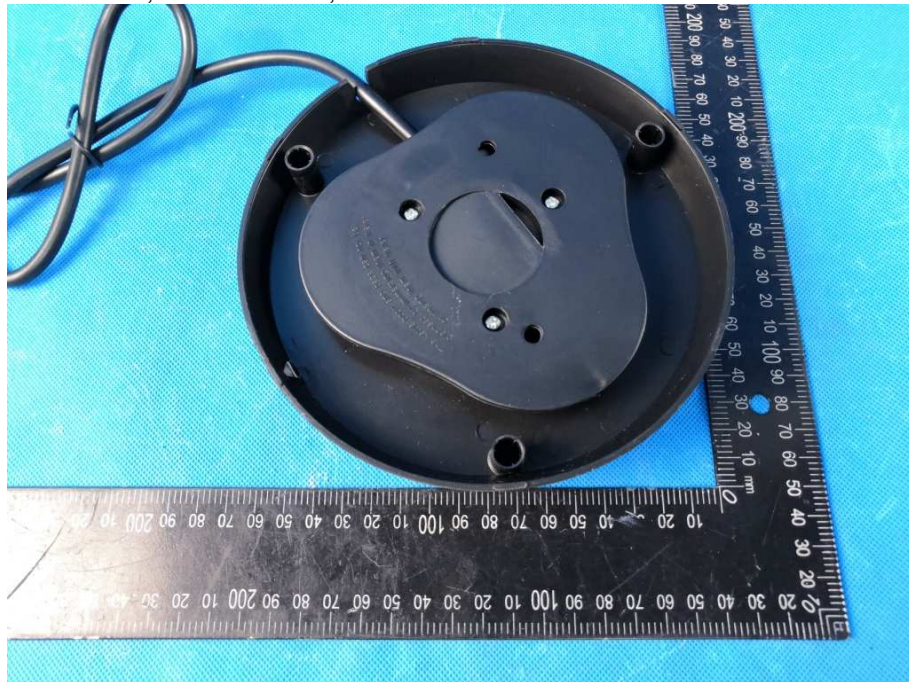

View of level mark, TPSK0318-15, TPSK0318-18



Internal view of stand, TPSK0318-15, TPSK0318-18



Internal view of kettle, TPSK0318-15, TPSK0318-18



Internal view of kettle, TPSK0318-15, TPSK0318-18

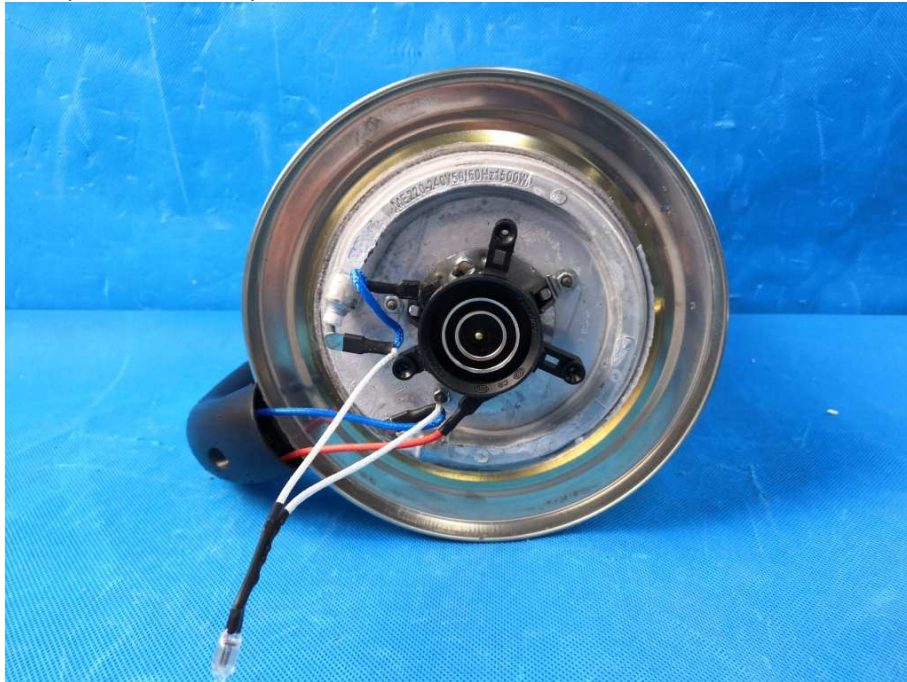

View of indicator, TPSK0318-15, TPSK0318-18

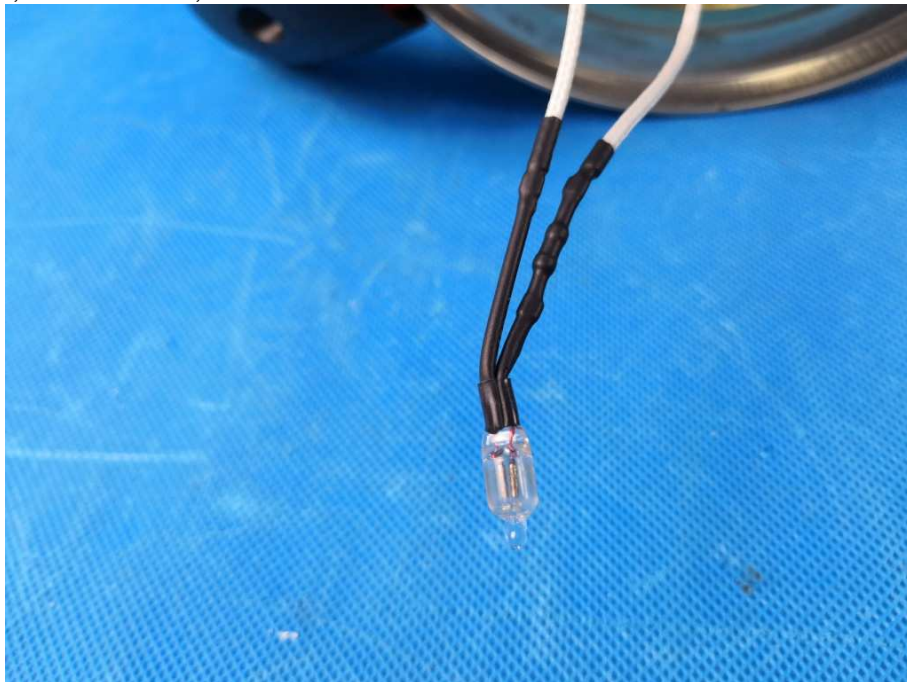

Internal view of handle, TPSK0318-15, TPSK0318-18



Overall view of model TPSK0518-15, TPSK0518-18,
which are identical to TPSK0318-15, TPSK0318-18 except different shape of lid and handle.



Photo Documents

Overall view of model TPSK0315-15, TPSK0315-18,
which are identical to TPSK0318-15, TPSK0318-18 except different size and rated capacity.



Overall view of model TPSK0515-15, TPSK0515-18,
which are identical to TPSK0518-15, TPSK0518-18 except different size and rated capacity.



Overall view, TPSK5218SS-15, TPSK5218SS-18, front



Overall view, TPSK5218SS-15, TPSK5218SS-18, rifht



Overall view, TPSK5218SS-15, TPSK5218SS-18, rear



Overall view, TPSK5218SS-15, TPSK5218SS-18, left

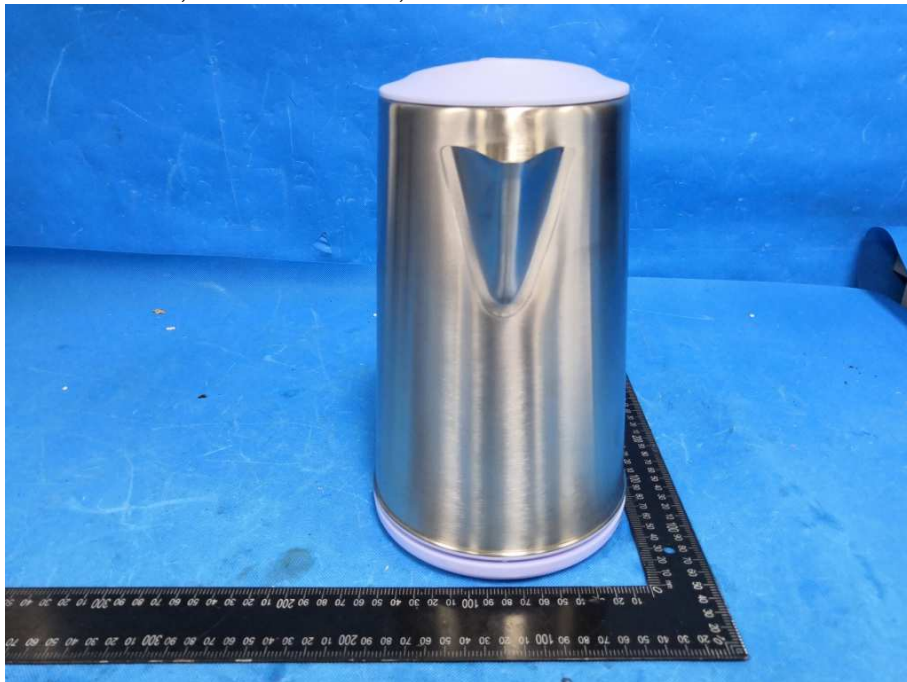
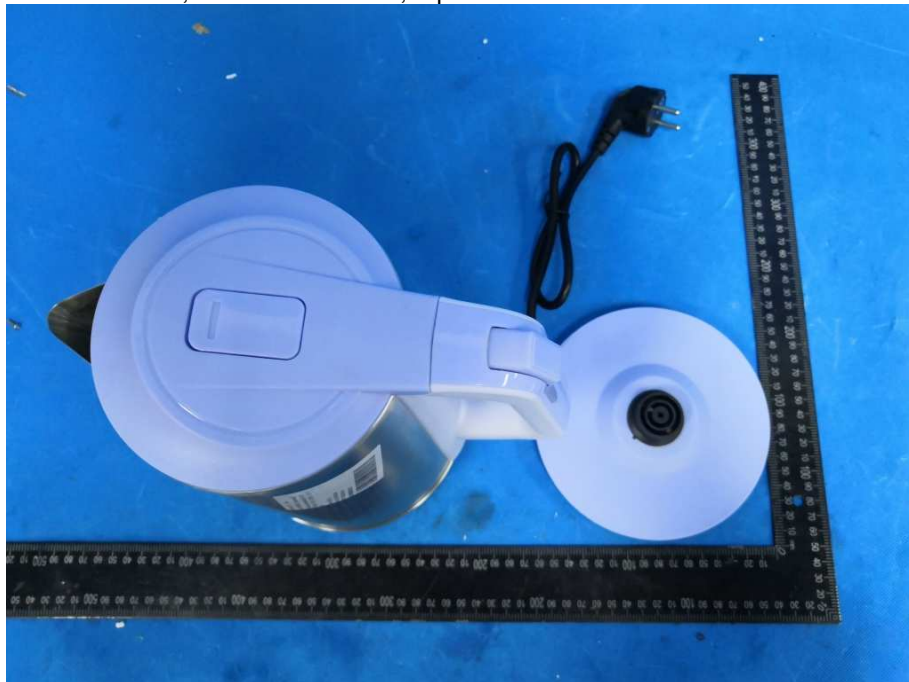

Photo Documents

Overall view, TPSK5218SS-15, TPSK5218SS-18, top



Overall view, TPSK5218SS-15, TPSK5218SS-18, kettle bottom

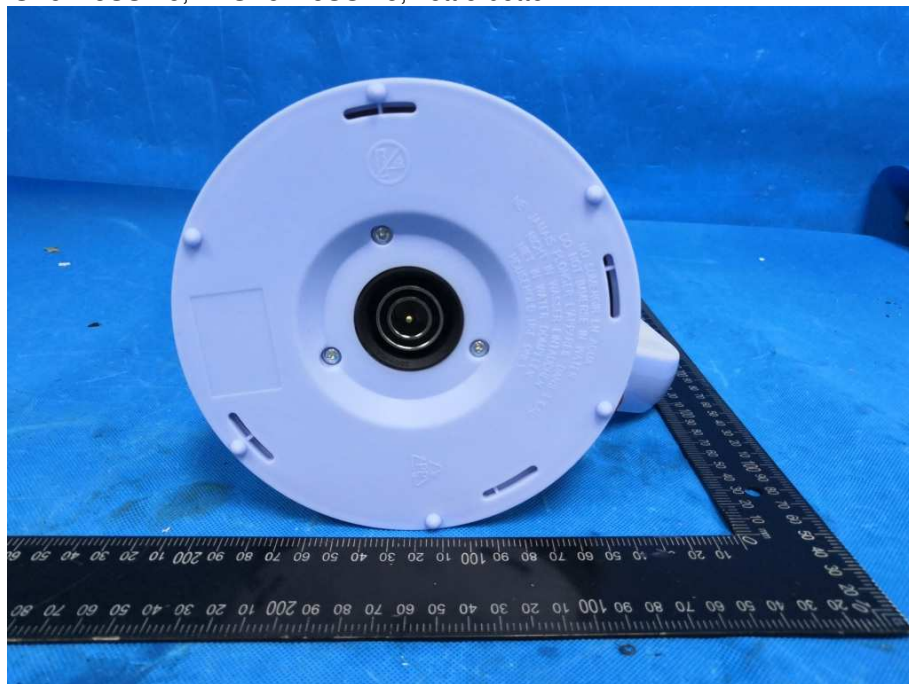
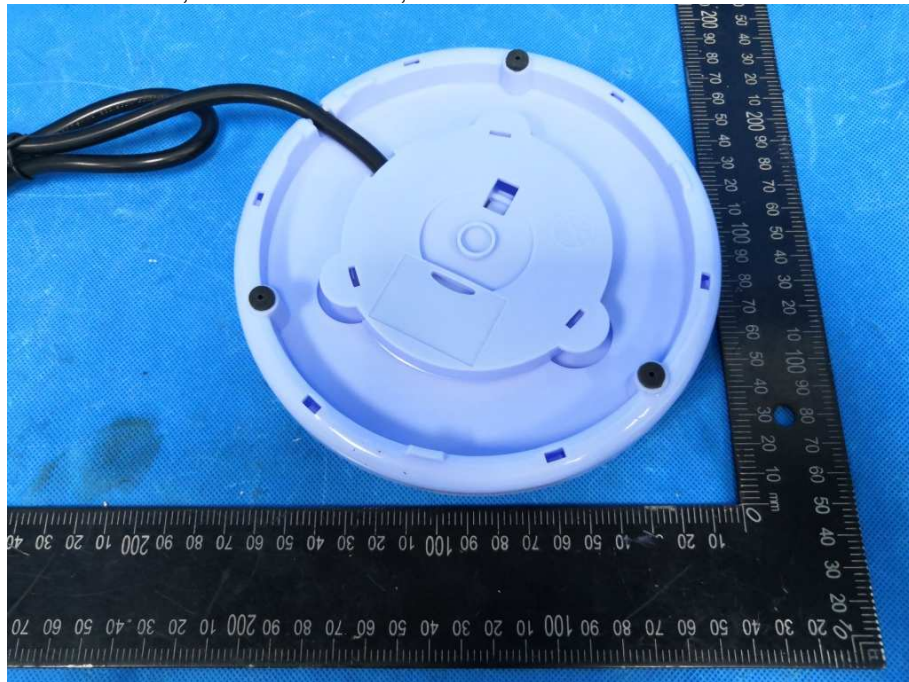

Photo Documents

Overall view, TPSK5218SS-15, TPSK5218SS-18, stand bottom



View of water level mark, TPSK5218SS-15, TPSK5218SS-18



Internal view of stand, TPSK5218SS-15, TPSK5218SS-18

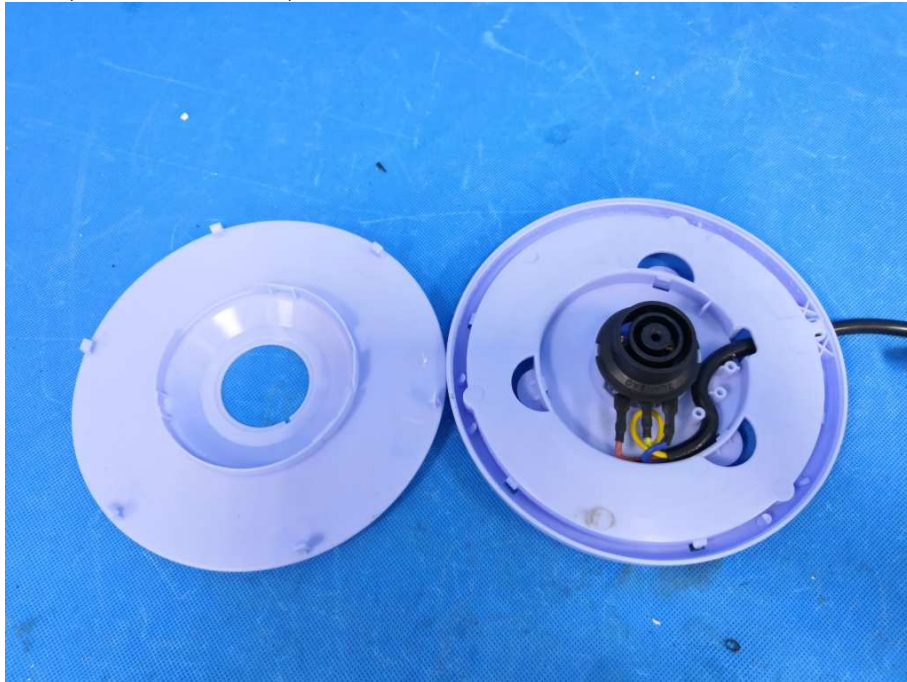

Internal view of kettle, TPSK5218SS-15, TPSK5218SS-18

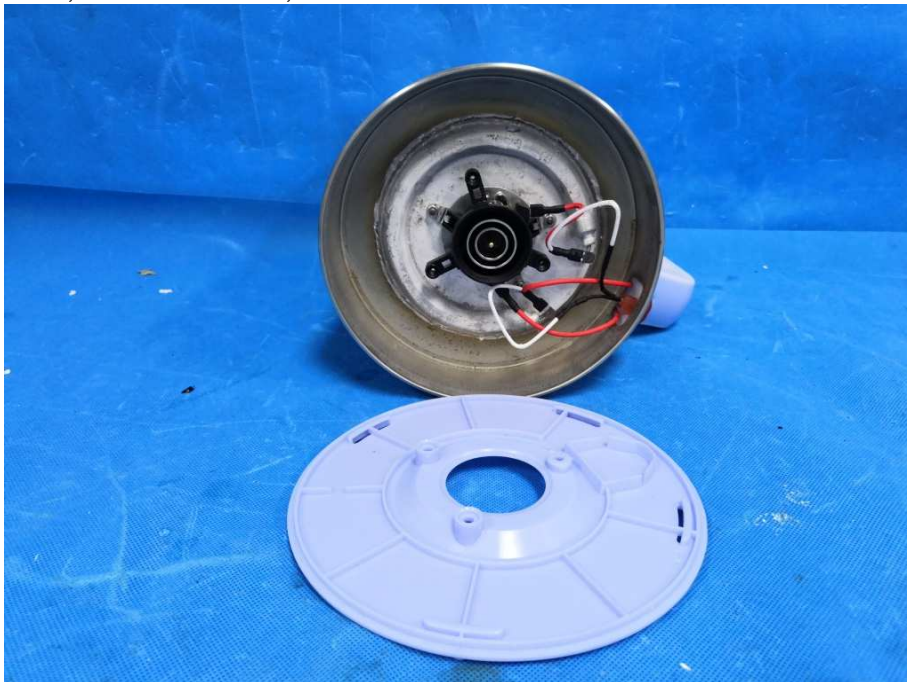

Overall view, TPSK7318-15, TPSK7318-18 front



Overall view, TPSK7318-15, TPSK7318-18 right



Photo Documents

Overall view, TPSK7318-15, TPSK7318-18 rear



Overall view, TPSK7318-15, TPSK7318-18 left



Overall view, TPSK7318-15, TPSK7318-18 top

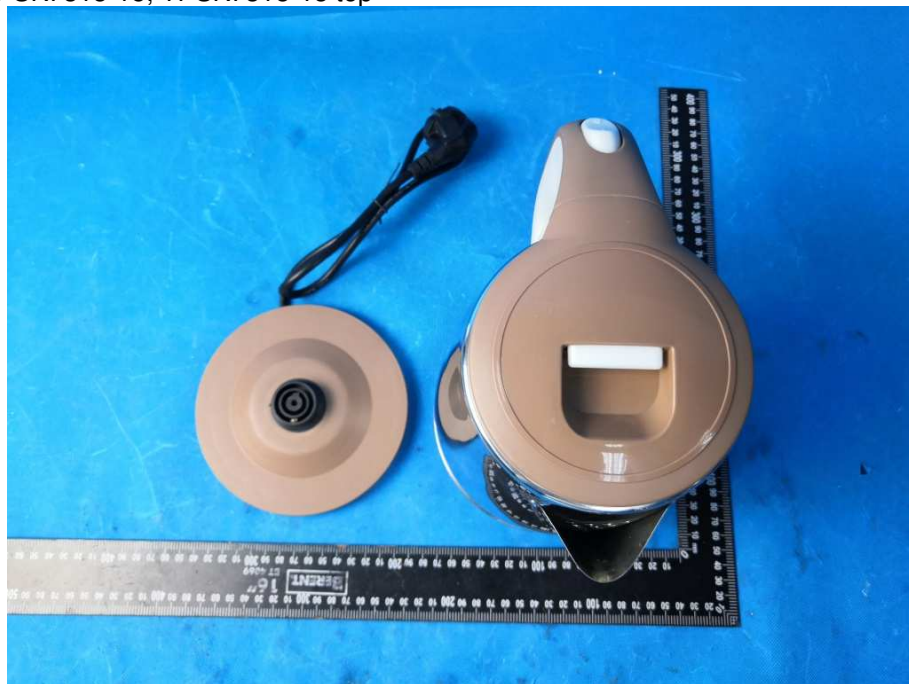

Overall view, TPSK7318-15, TPSK7318-18 kettle bottom

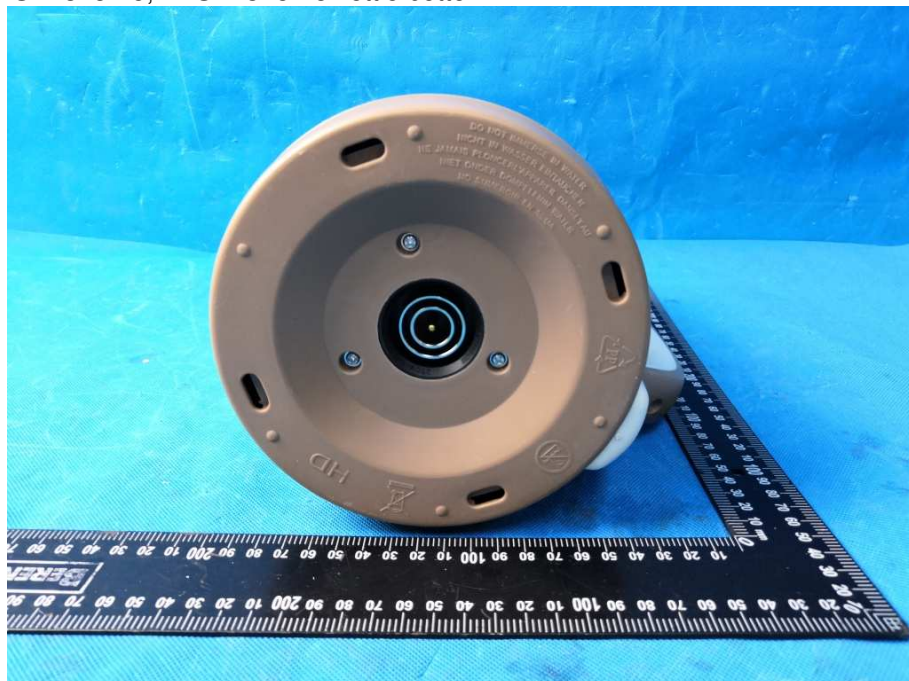

Photo Documents

Overall view, TPSK7318-15, TPSK7318-18 stand bottom



View of water level mark, TPSK7318-15, TPSK7318-18



Internal view of stand, TPSK7318-15, TPSK7318-18

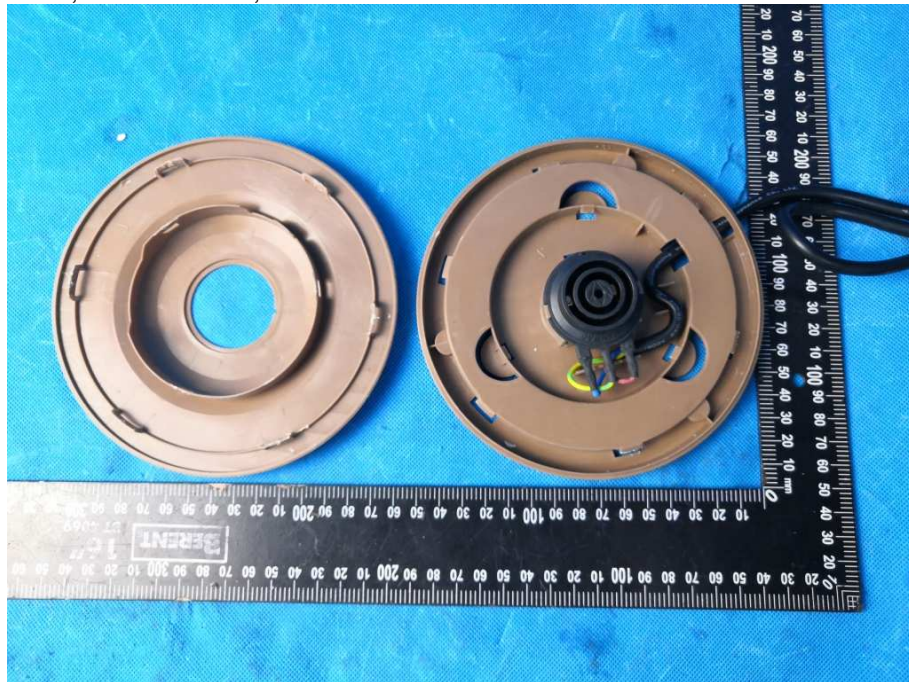

Internal view of kettle, TPSK7318-15, TPSK7318-18



Internal view of kettle, TPSK7318-15, TPSK7318-18

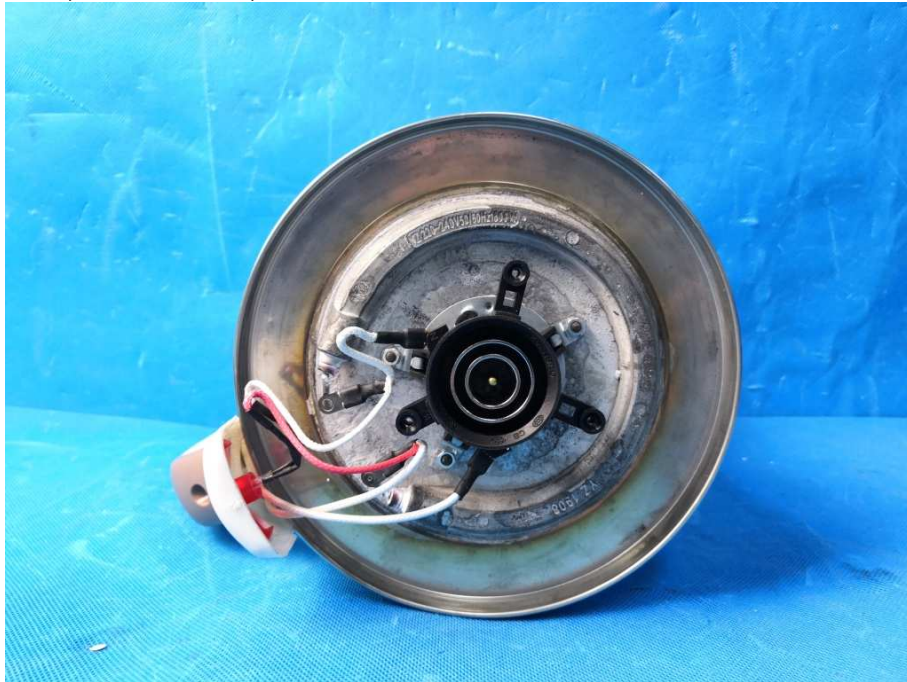

Internal view of handle, TPSK7318-15, TPSK7318-18



Overall view, TPSK7425-15, TPSK7425-18 front



Overall view, TPSK7425-15, TPSK7425-18 right



Overall view, TPSK7425-15, TPSK7425-18 rear



Overall view, TPSK7425-15, TPSK7425-18 left



Overall view, TPSK7425-15, TPSK7425-18 top



Overall view, TPSK7425-15, TPSK7425-18 kettle bottom

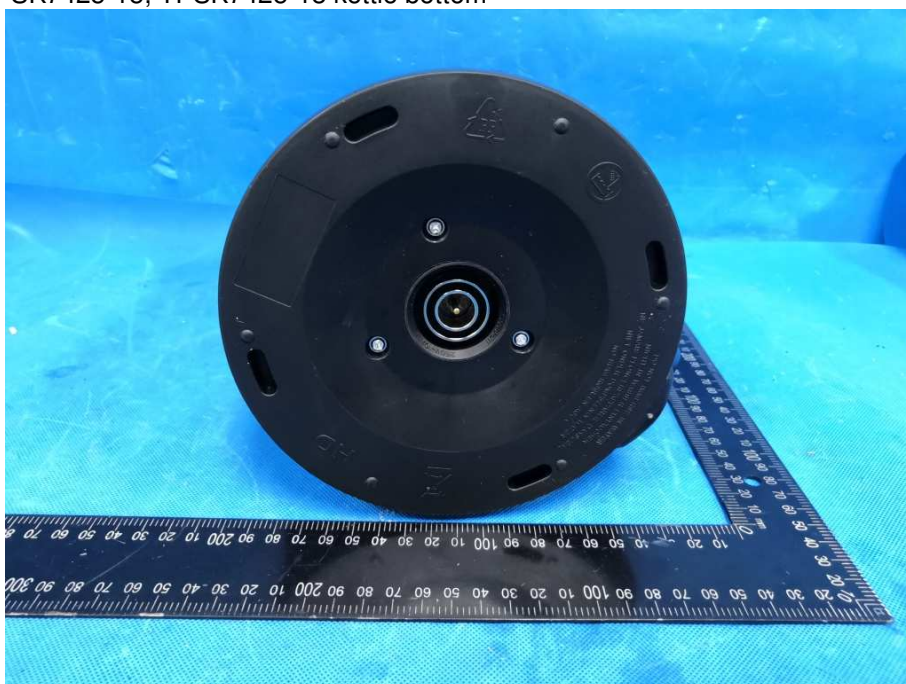
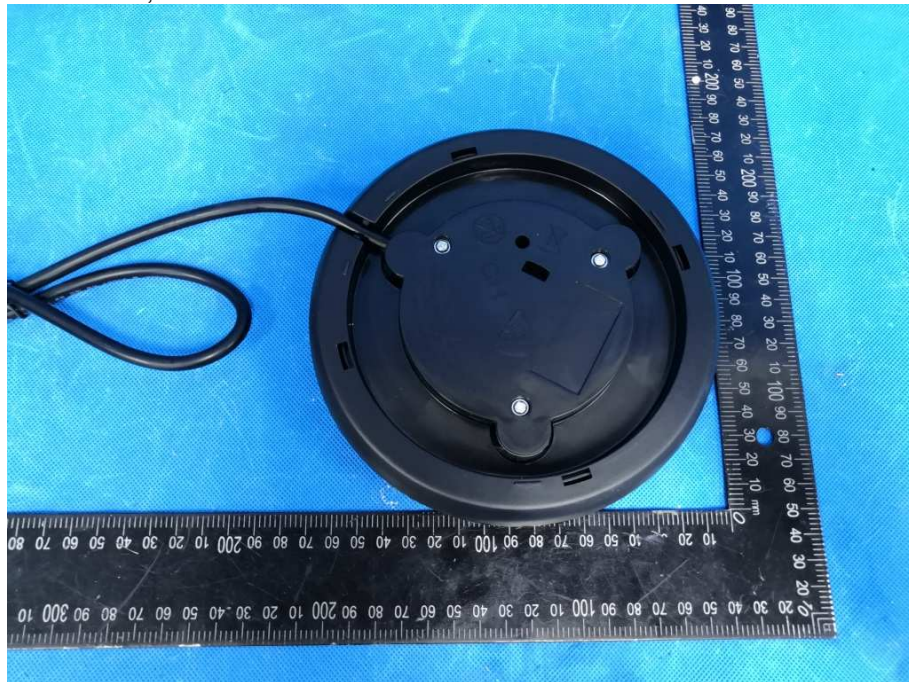

Photo Documents

Overall view, TPSK7425-15, TPSK7425-18 stand bottom



View of water level mark, TPSK7425-15, TPSK7425-18



Internal view of stand, TPSK7425-15, TPSK7425-18



Internal view of handle, TPSK7425-15, TPSK7425-18



Photo Documents

Internal view of kettle, TPSK7425-15, TPSK7425-18



Internal view of kettle, TPSK7425-15, TPSK7425-18



Overall view, TPSK7625-15, TPSK7625-18 front



Overall view, TPSK7625-15, TPSK7625-18 right



Overall view, TPSK7625-15, TPSK7625-18 rear



Overall view, TPSK7625-15, TPSK7625-18 stand left



Overall view, TPSK7625-15, TPSK7625-18 top



Overall view, TPSK7625-15, TPSK7625-18 kettle bottom

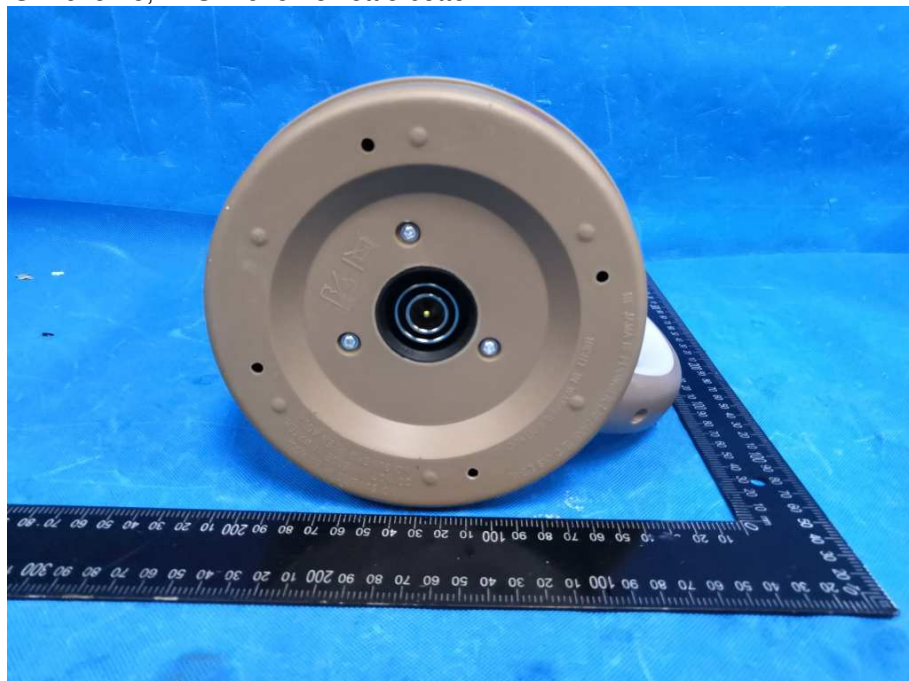
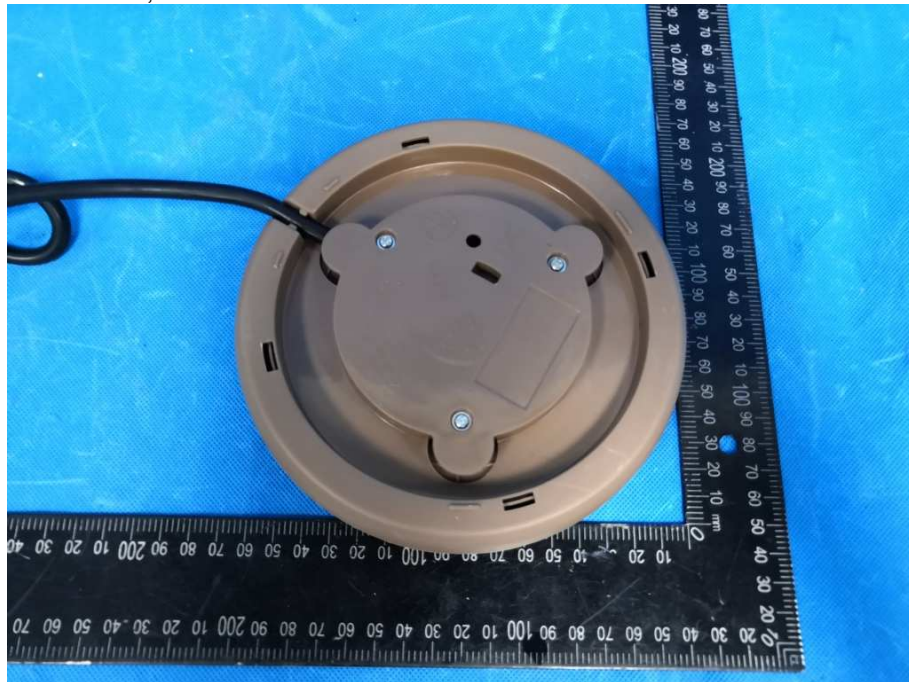

Photo Documents

Overall view, TPSK7625-15, TPSK7625-18 stand bottom



View of water level mark, TPSK7625-15, TPSK7625-18



Internal view of kettle, TPSK7625-15, TPSK7625-18

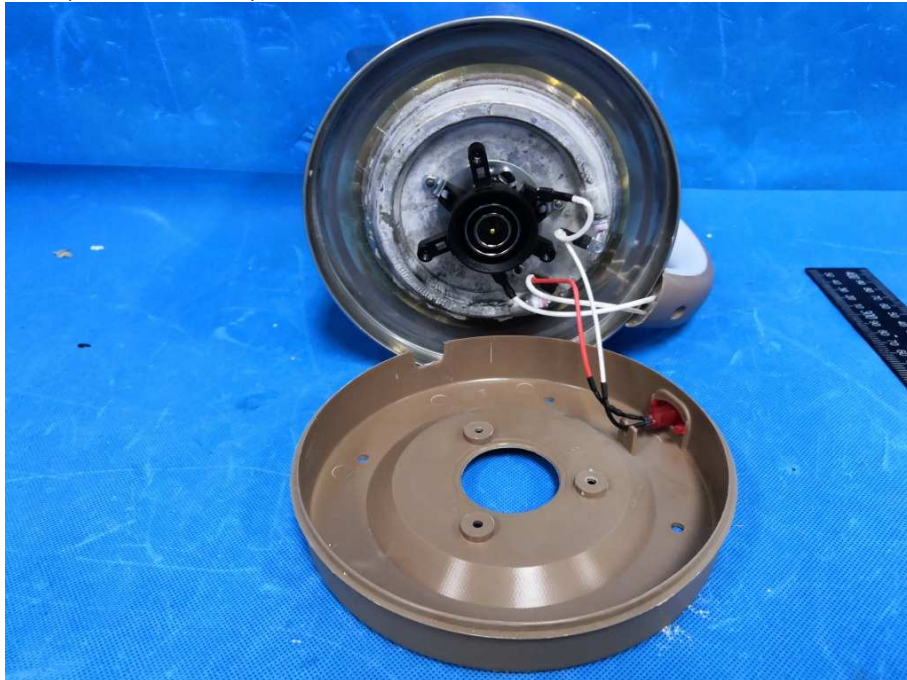

Internal view of kettle, TPSK7625-15, TPSK7625-18

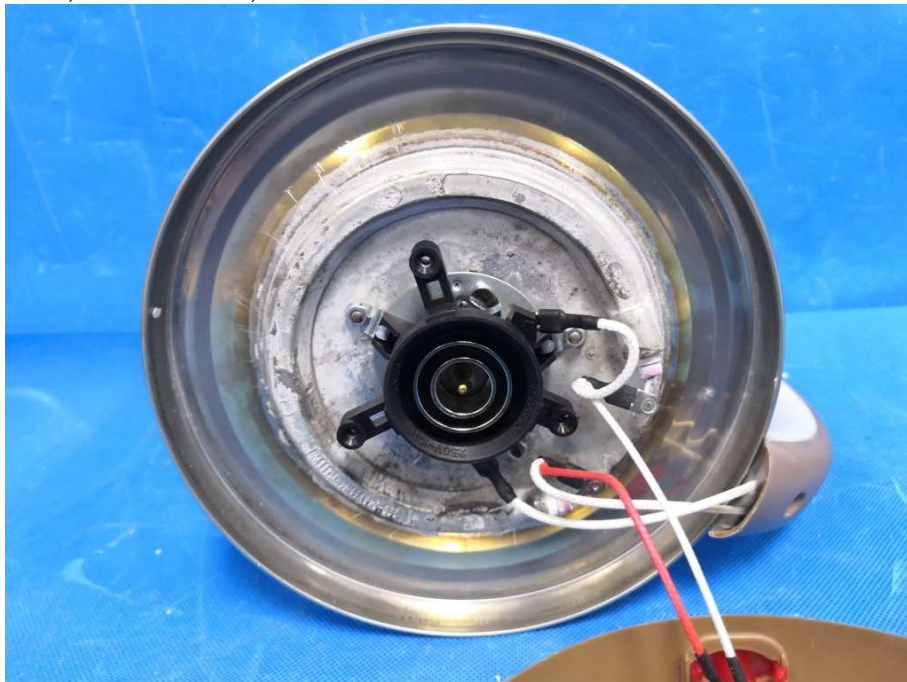

Internal view of handle, TPSK7625-15, TPSK7625-18



Internal view of stand, TPSK7625-15, TPSK7625-18



Overall view, TPSK8518-15, TPSK8518-18, front



Overall view, TPSK8518-15, TPSK8518-18, right



Overall view, TPSK8518-15, TPSK8518-18, rear



Overall view, TPSK8518-15, TPSK8518-18, left



Overall view, TPSK8518-15, TPSK8518-18, top



Overall view, TPSK8518-15, TPSK8518-18, kettle bottom



Photo Documents

Overall view, TPSK8518-15, TPSK8518-18, stand bottom

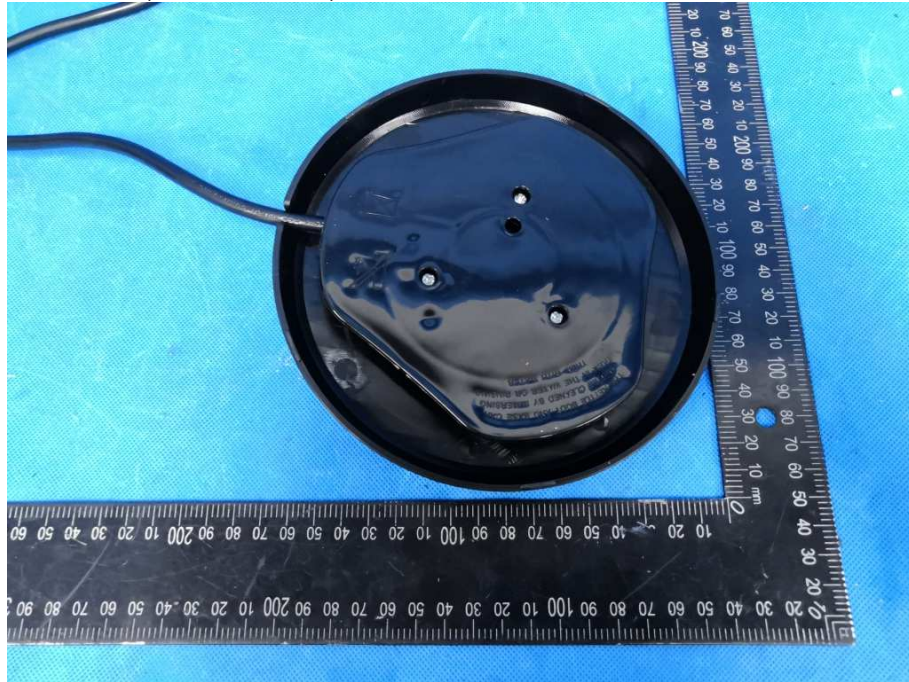

View of water level mark, TPSK8518-15, TPSK8518-18



Internal view of stand, TPSK8518-15, TPSK8518-18



Internal view of kettle, TPSK8518-15, TPSK8518-18

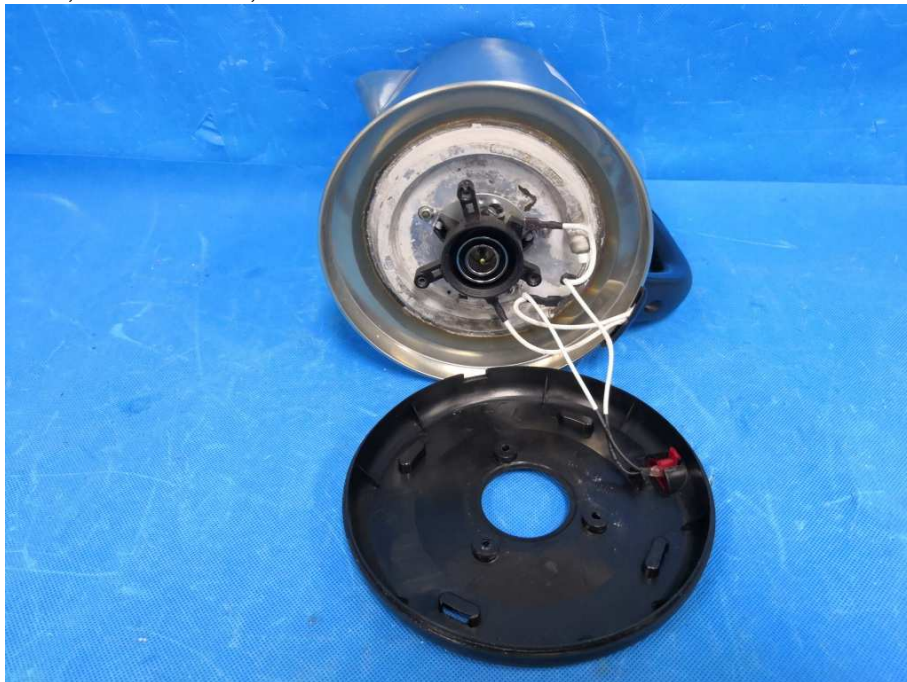

Internal view of kettle, TPSK8518-15, TPSK8518-18



Internal view of handle, TPSK8518-15, TPSK8518-18



Overall view, TPCK0118-18, front



Overall view, TPCK0118-18, right



Overall view, TPCK0118-18, rear



Overall view, TPCK0118-18, left



Overall view, TPCK0118-18, top



Overall view, TPCK0118-18, kettle bottom

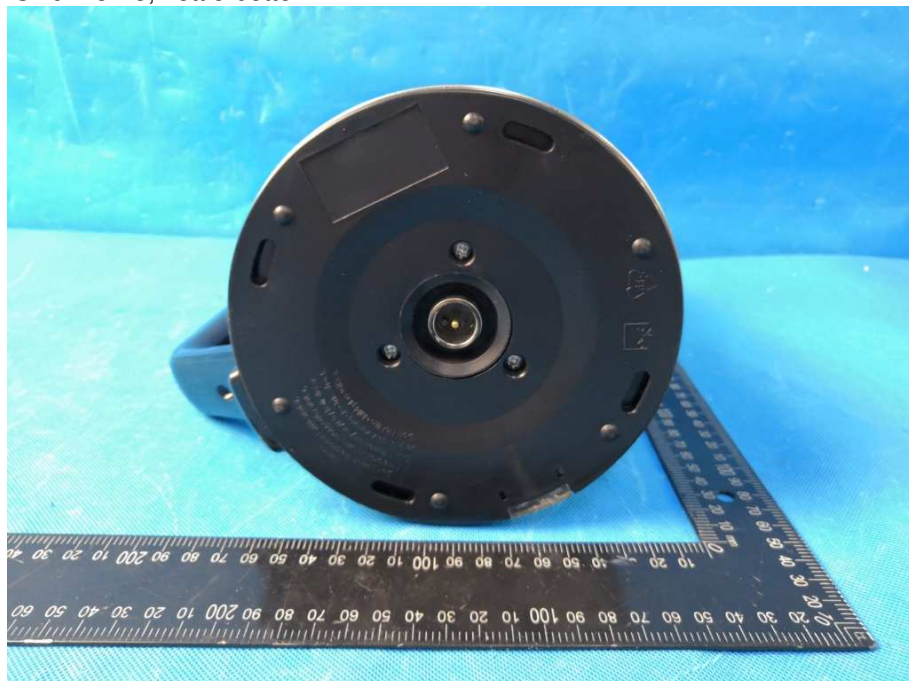

Overall view, TPCK0118-18, stand bottom



View of water level mark, TPCK0118-18



Internal view of stand, TPCK0118-18



Internal view of kettle, TPCK0118-18

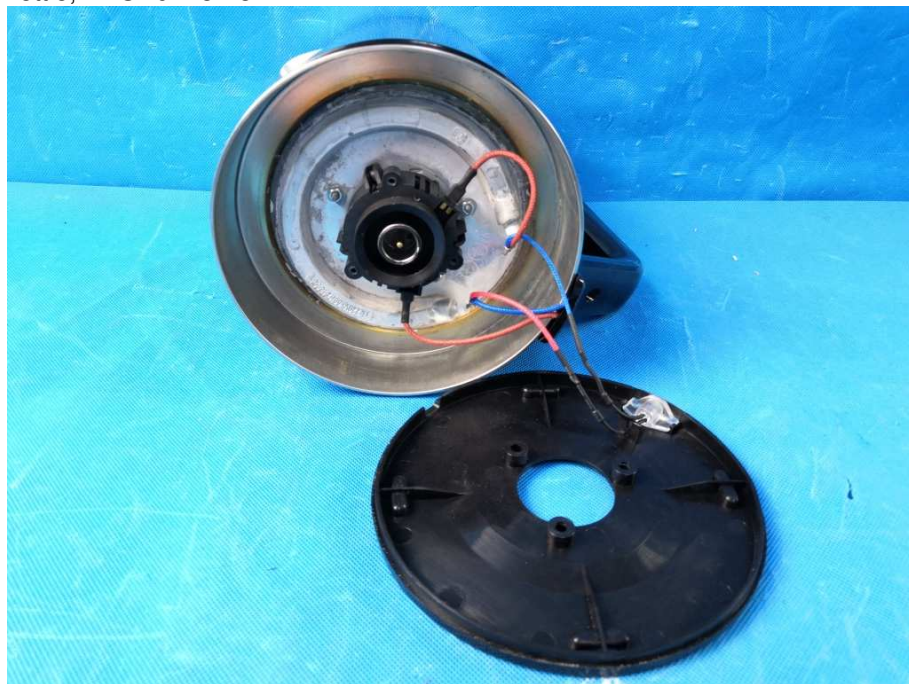

Overall view, TPCK0225-18, front



Overall view, TPCK0225-18, right



Overall view, TPCK0225-18, rear



Overall view, TPCK0225-18, left



Overall view, TPCK0225-18, top



Overall view, TPCK0225-18, kettle bottom

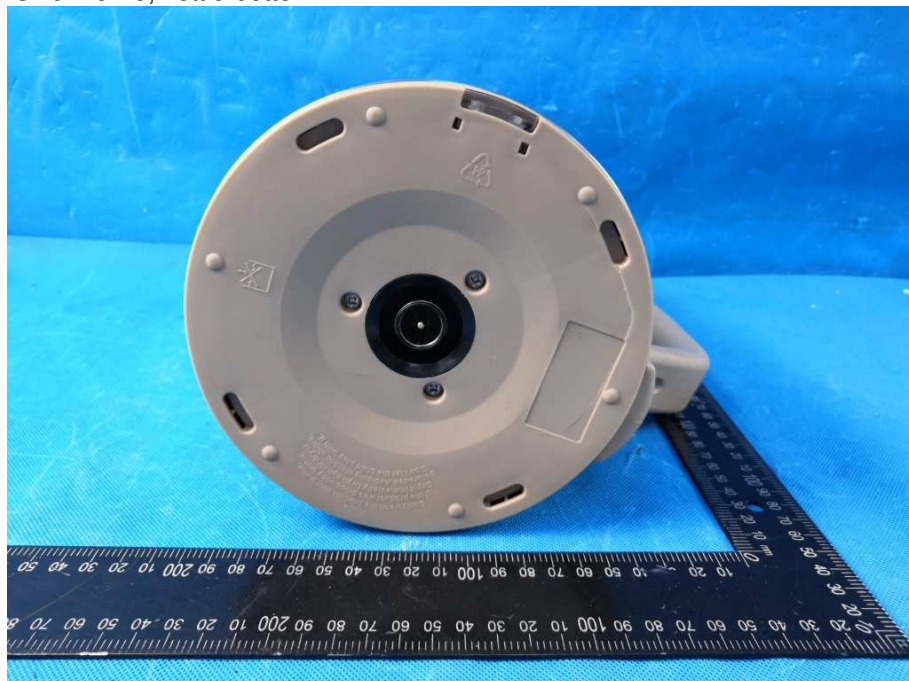

Overall view, TPCK0225-18, stand bottom

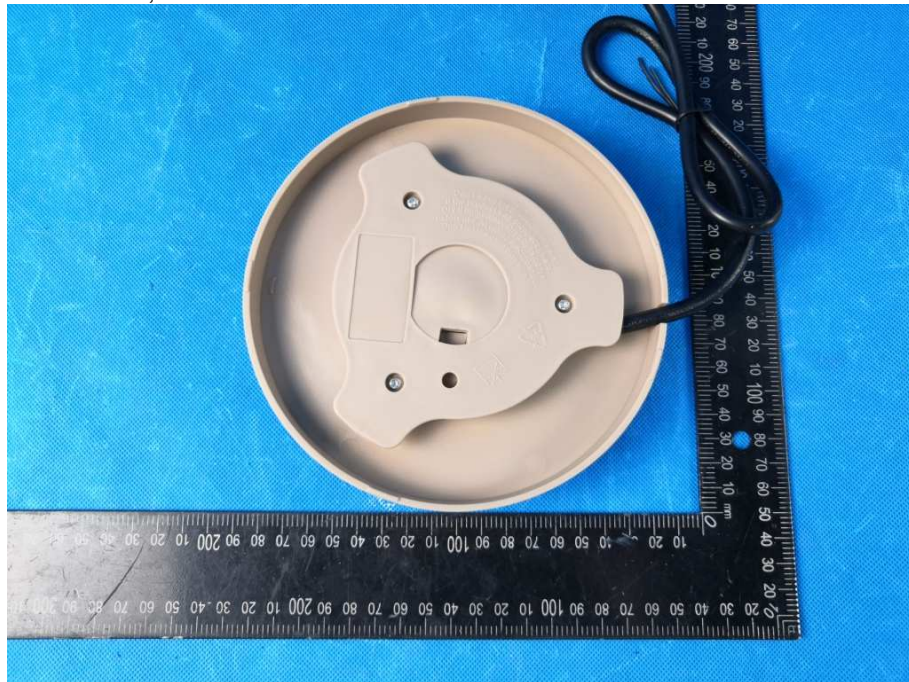

Internal view of stand, TPCK0225-18



Internal view of kettle, TPCK0225-18

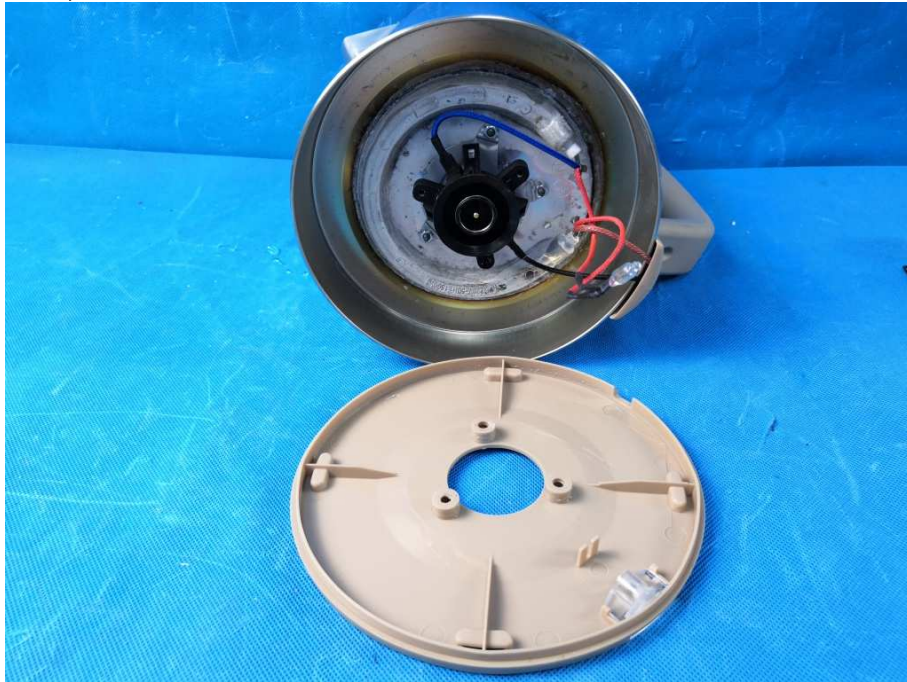

Internal view of handle, TPCK0225-18



Overall view, TPCK0318-18, front



Overall view, TPCK0318-18, right



Overall view, TPCK0318-18, rear



Overall view, TPCK0318-18, left



Overall view, TPCK0318-18, top

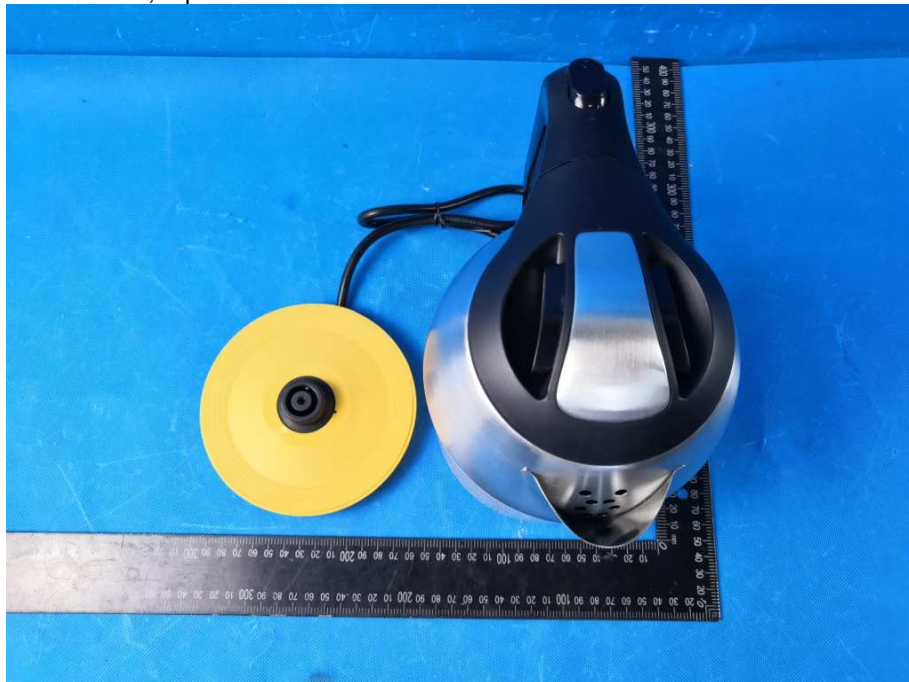

Overall view, TPCK0318-18, kettle bottom

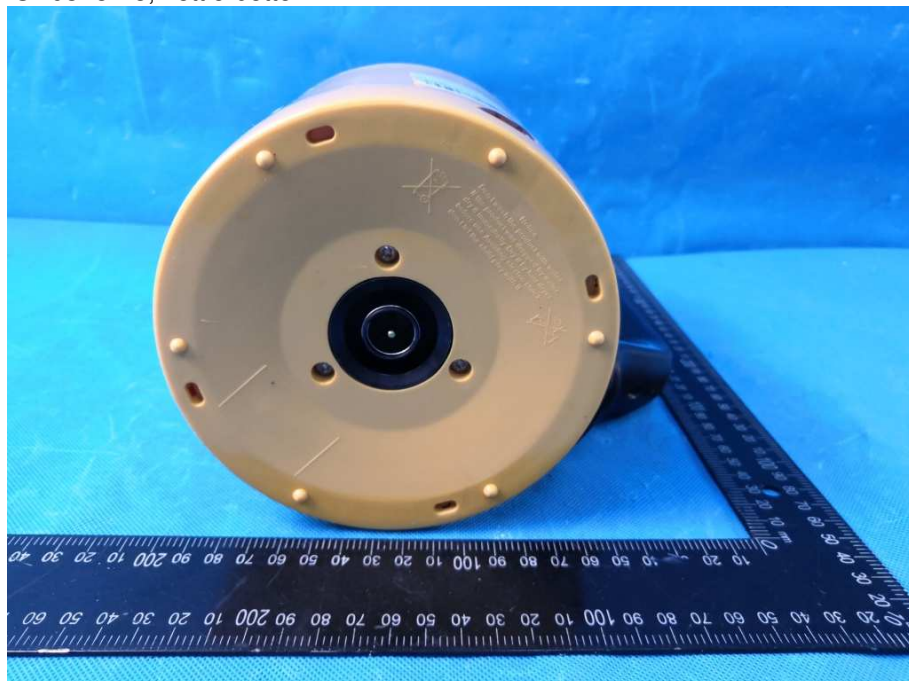

Overall view, TPCK0318-18, stand bottom

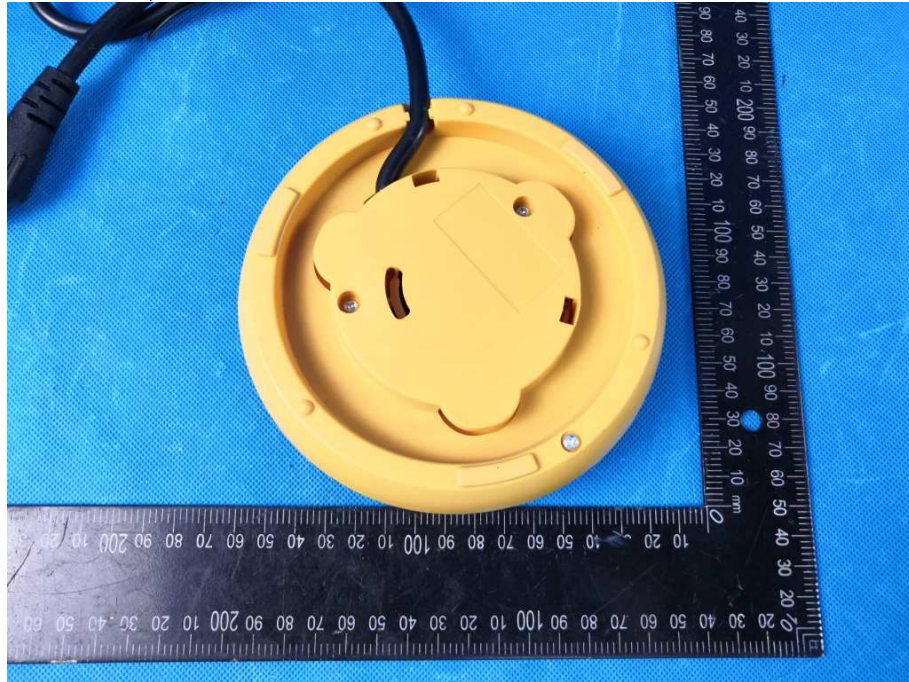

View of water level mark, TPCK0318-18



Internal view of stand, TPCK0318-18

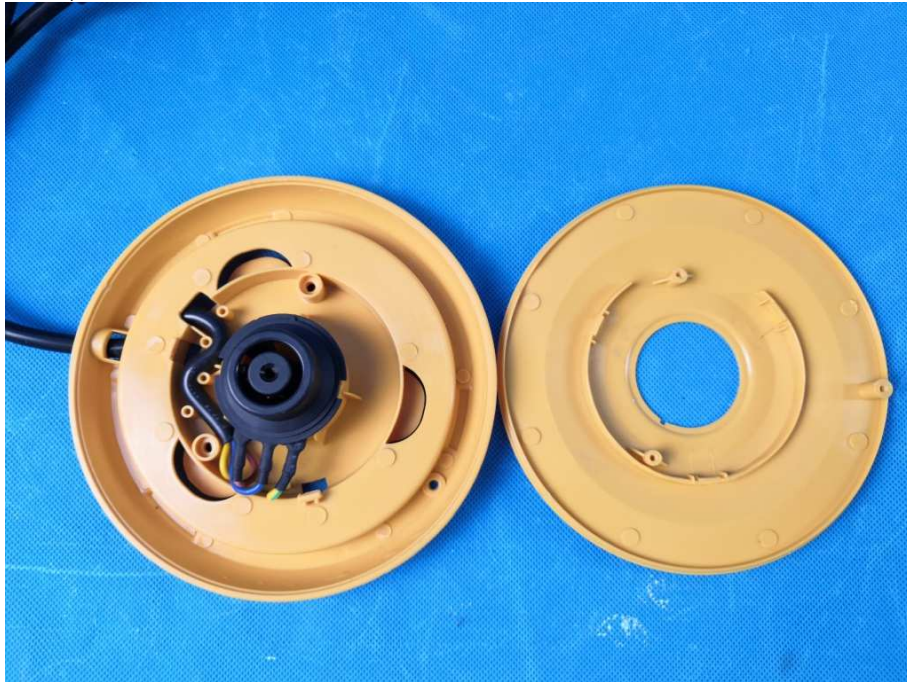

Internal view of kettle, TPCK0318-18

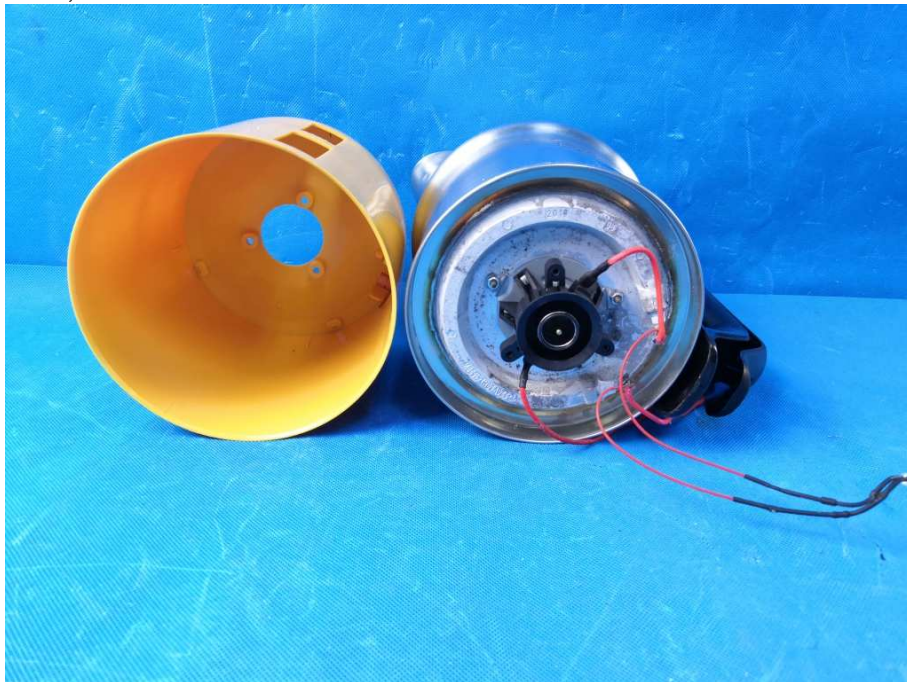

Overall view, TPCK0418-18 front



Overall view, TPCK0418-18 right



Overall view, TPCK0418-18 rear



Overall view, TPCK0418-18 left



Overall view, TPCK0418-18 top



Overall view, TPCK0418-18 stand bottom



Overall view, TPCK0418-18 kettle bottom

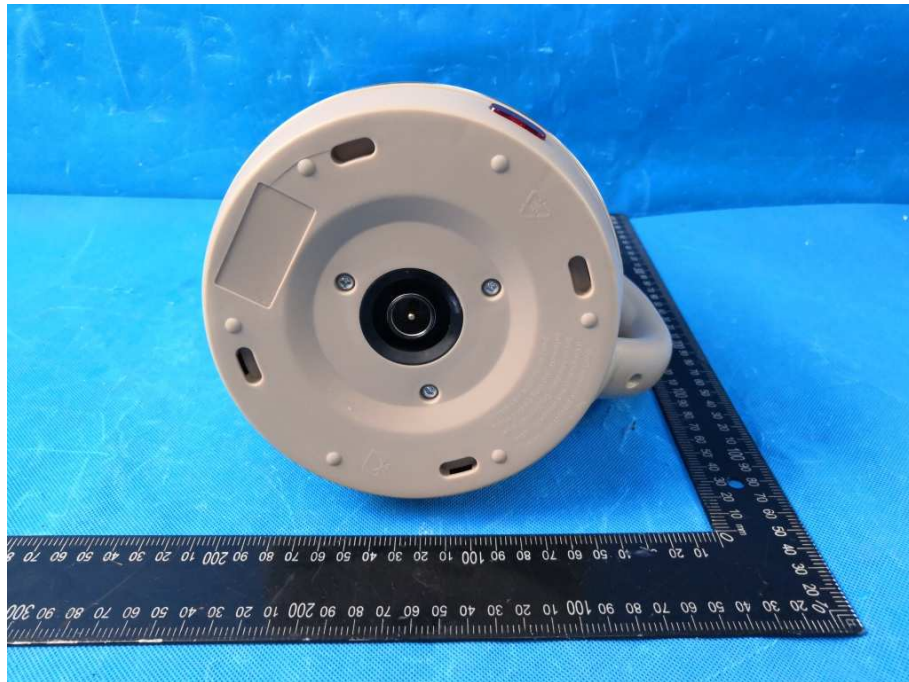

View of water level mark, TPCK0418-18



Internal view of stand TPCK0418-18

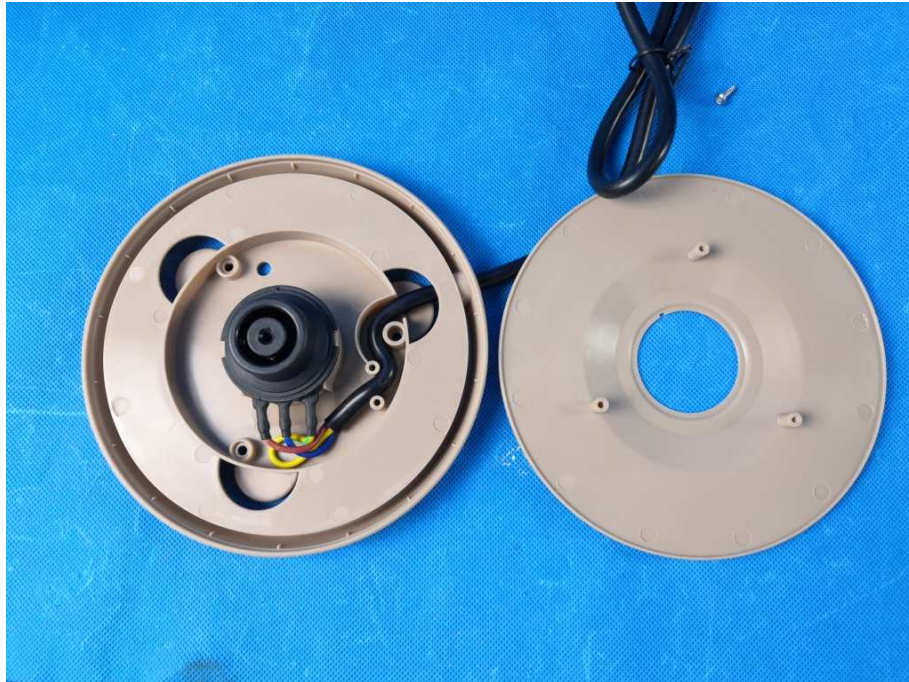

Internal view of kettle TPCK0418-18

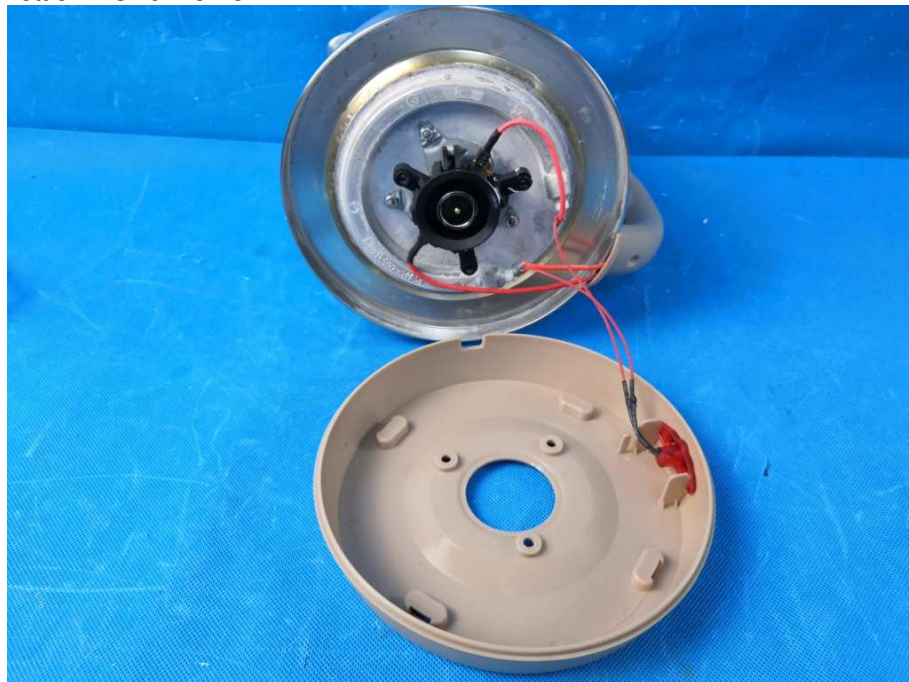

Overall view, TPCK0508-13, front



Overall view, TPCK0508-13, right



Overall view, TPCK0508-13, rear



Overall view, TPCK0508-13, left



Overall view, TPCK0508-13, top

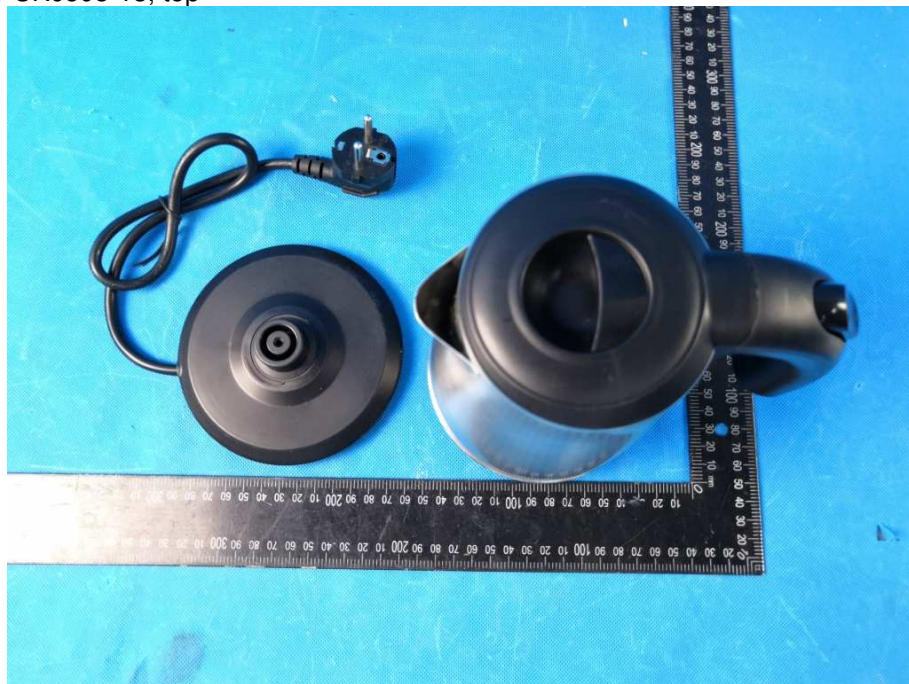

Overall view, TPCK0508-13, kettle bottom



Overall view, TPCK0508-13, stand bottom



View of water level mark, TPCK0508-13



Internal view of stand, TPCK0508-13



Internal view of kettle, TPCK0508-13



Internal view of handle, TPCK0508-13



Overall view, TPSK8815-15, TPSK8815-18 front



Photo Documents

Overall view, TPSK8815-15, TPSK8815-18, right



Overall view, TPSK8815-15, TPSK8815-18, rear



Photo Documents

Overall view, TPSK8815-15, TPSK8815-18, left



Overall view, TPSK8815-15, TPSK8815-18, top



Photo Documents

Overall view, TPSK8815-15, TPSK8815-18, kettle bottom

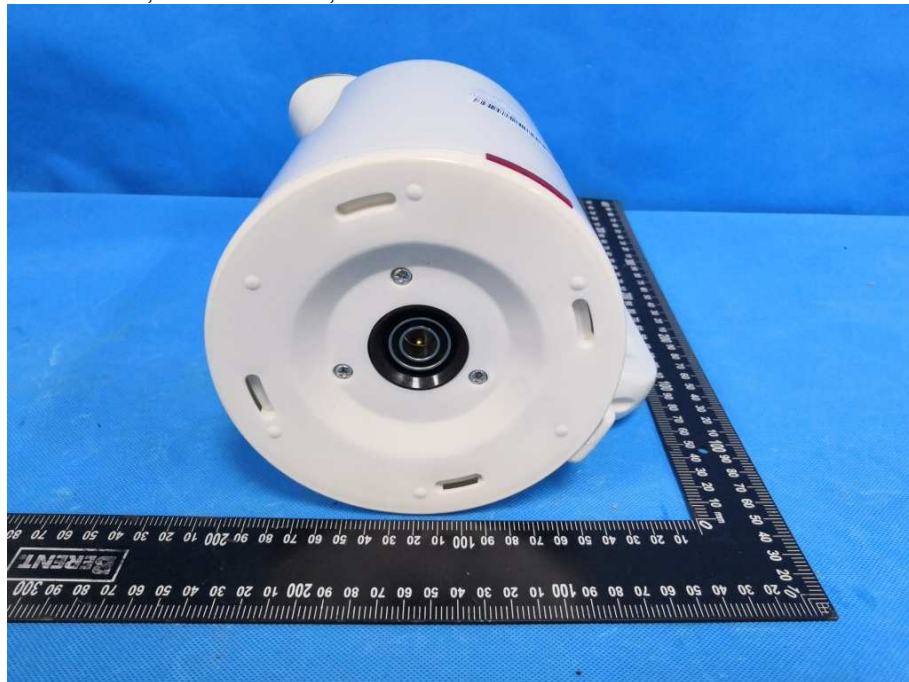

Overall view, TPSK8815-15, TPSK8815-18, stand bottom

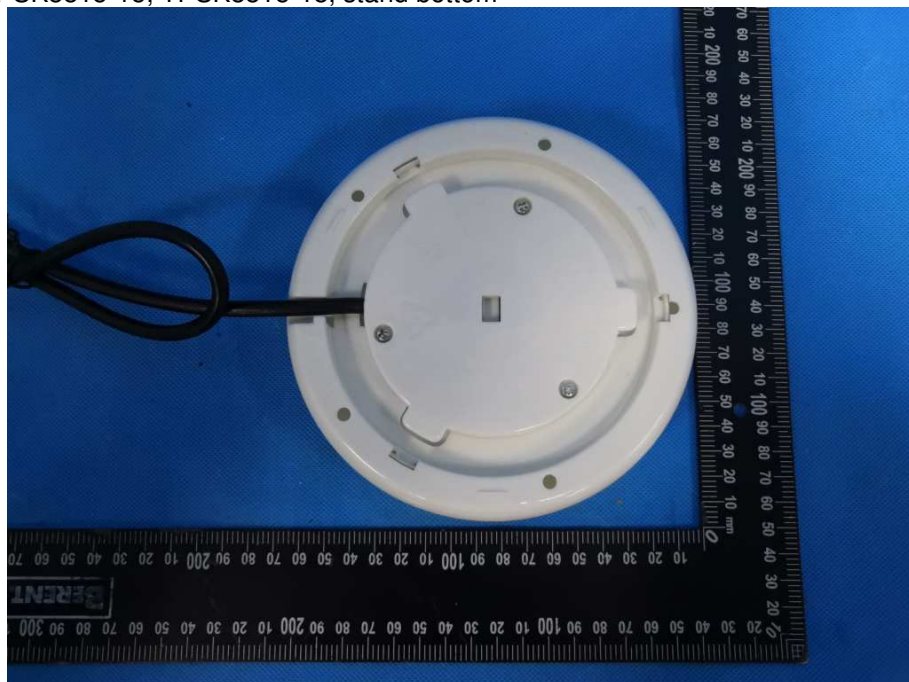
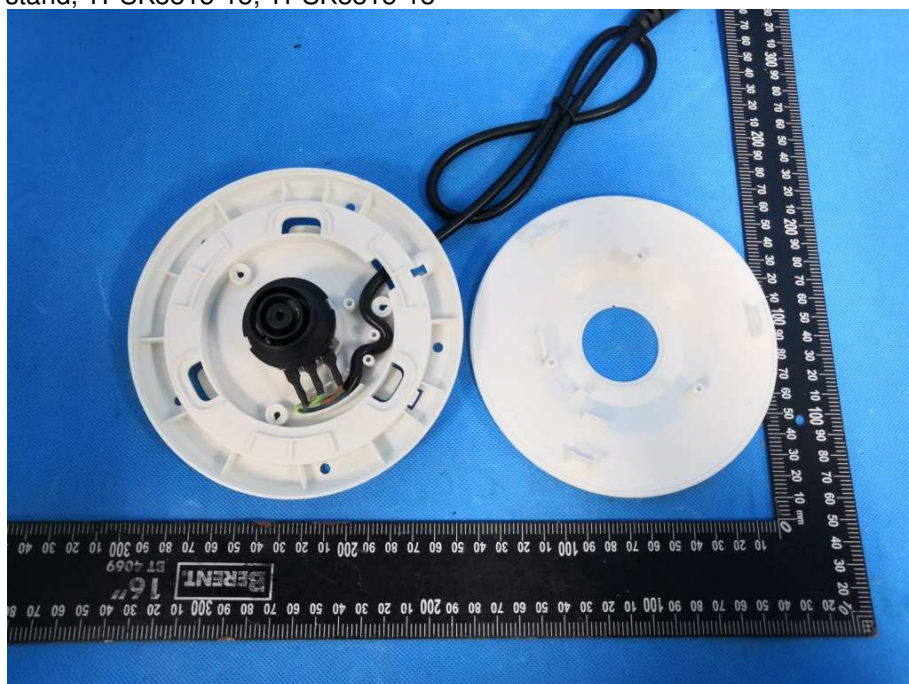

Photo Documents

View of water level mark, TPSK8815-15, TPSK8815-18



Internal view of stand, TPSK8815-15, TPSK8815-18



Internal view of kettle, TPSK8815-15, TPSK8815-18



Internal view of handle, TPSK8815-15, TPSK8815-18



View of connector (TIANMING)

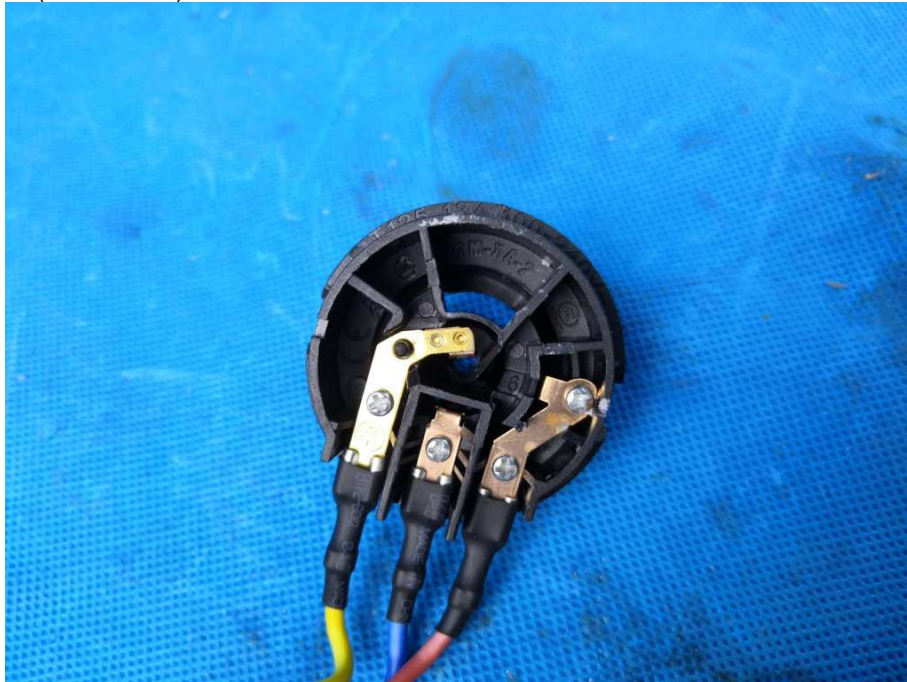

View of temperature limiter (TIANMING)



View of thermal control (TIANMING)



View of thermal control (TIANMING)

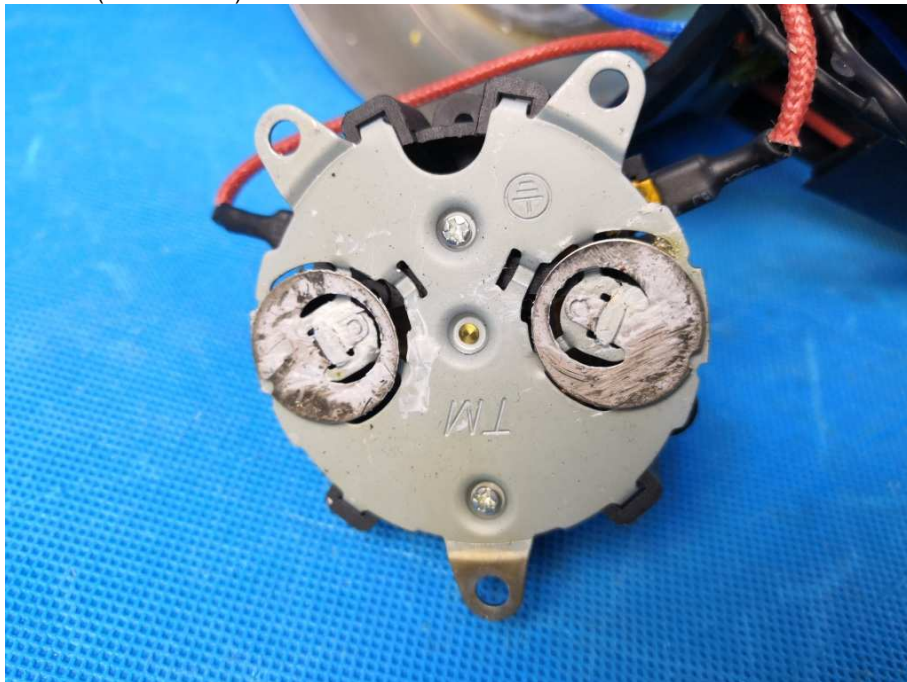

View of connector (FUFAN)



View of temperature limiter (FUFAN)

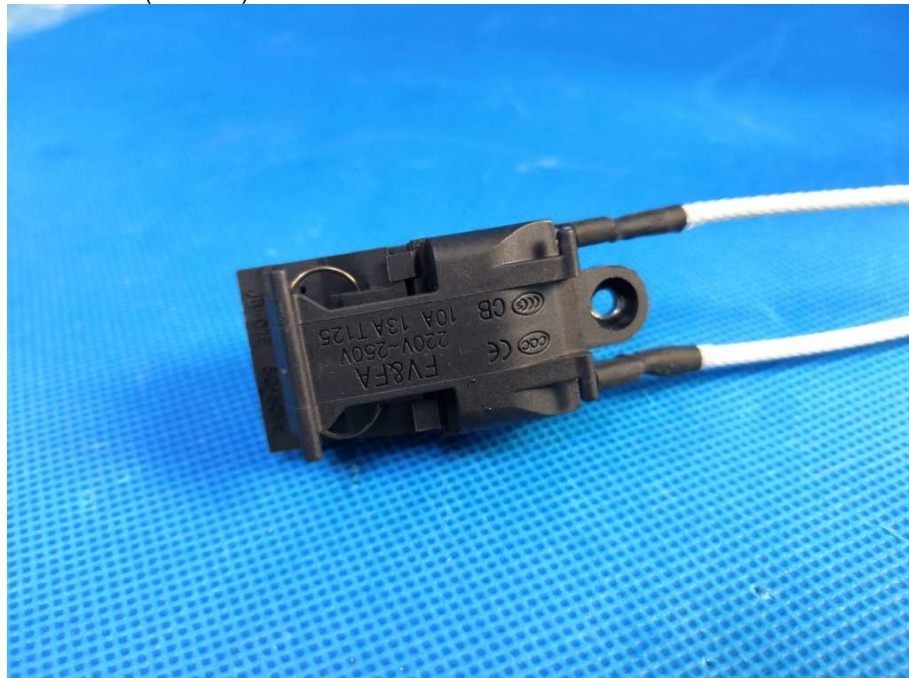

View of thermal control (FUFAN)



View of thermal control (FUFAN)

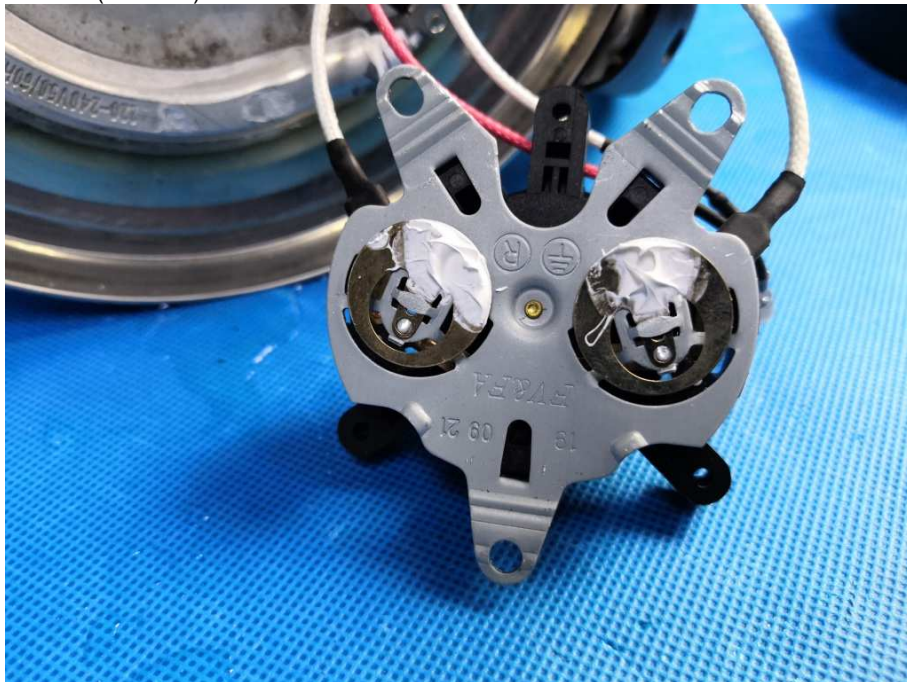

Circuit diagram for all models:

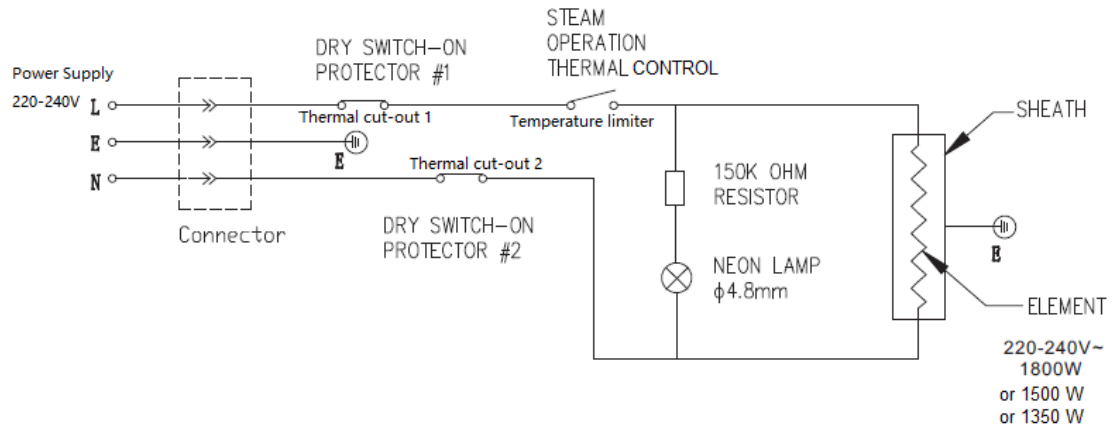

---End of Report---